



aerospace
climate control
electromechanical
filtration
fluid & gas handling
hydraulics
pneumatics
process control
sealing & shielding



Pneumatic Air Motors

P1V-M robust type
0.2, 0.4, 0.6, 0.9 & 1.2 kW

Catalogue PDE2539TCUK August 2014



ENGINEERING YOUR SUCCESS.

Contents	Page
Features	3 - 4
Robust air motors P1V-M	5
Principles of air motors	6
The steps to size	7 - 11
Air quality	12
Material and technical specification	14
Choice of air motor	15
Robust air motors without gear boxes, 200 to 1200 watts	16
Dimensions	17
Robust air motors with gear box 200 watts	18
Dimensions	19
Robust air motors with gear box 400 watts	20
Dimensions	21
Robust air motors with gear box 600 watts	22
Dimensions	23
Robust air motors with gear box 900 watts	24
Dimensions	25
Robust air motors with gear box 1200 watts	26
Dimensions	27
Permitted shaft loadings	28
Order key	29
Service - Easier - Faster - Cheaper	30 - 31
P3X Air Preparation System	32
Introduction to ATEX directive	33 - 35
Declaration of Conformity	36



Important
 Before carrying out service activities, make sure the air motor is vented. Before disassembling the motor, disconnect the primary air hose to ensure that the air supply is interrupted.



Note
 All technical data in the catalogue are typical values.
 The air quality is a major factor in the service life of the motor, see ISO 8573-1.



WARNING

FAILURE OR IMPROPER SELECTION OR IMPROPER USE OF THE PRODUCTS AND/OR SYSTEMS DESCRIBED HEREIN OR RELATED ITEMS CAN CAUSE DEATH, PERSONAL INJURY AND PROPERTY DAMAGE.

This document and other information from Parker Hannifin Corporation, its subsidiaries and authorized distributors provide product and/or system options for further investigation by users having technical expertise. It is important that you analyze all aspects of your application and review the information concerning the product or system in the current product catalog. Due to the variety of operating conditions and applications for these products or systems, the user, through its own analysis and testing, is solely responsible for making the final selection of the products and systems and assuring that all performance, safety and warning requirements of the application are met. The products described herein, including without limitation, product features, specifications, designs, availability and pricing, are subject to change by Parker Hannifin Corporation and its subsidiaries at any time without notice.

SALE CONDITIONS

The items described in this document are available for sale by Parker Hannifin Corporation, its subsidiaries or its authorized distributors. Any sale contract entered into by Parker will be governed by the provisions stated in Parker's standard terms and conditions of sale (copy available upon request).

P1V-M - Robust Air Motors

Features	Air motor	Hydraulic motor	Electric motor	Electric motor regulated	Electric motor regulated with feed back
Overload safe	***	***	*	**	***
Increased torque at higher loads	***	**	*	**	***
Easy to limit torque	***	***	*	*	***
Easy to vary speed	***	***	*	***	***
Easy to limit power	***	***	*	**	***
Reliability	***	***	***	***	***
Robustness	***	***	*	*	*
Installation cost	***	*	**	**	**
Ease of service	***	**	*	*	*
Safety in damp environments	***	***	*	*	*
Safety in explosive atmospheres	***	***	*	*	*
Safety risk with electrical installations	***	***	*	*	*
Risk of oil leak	***	*	***	***	***
Hydraulic system required	***	*	***	***	***
Weight	**	***	*	**	*
Power density	**	***	*	*	*
High torque for size	**	***	*	*	*
Noise level during operation	*	***	**	**	**
Total energy consumption	*	**	***	***	***
Service interval	*	**	***	***	***
Compressor capacity required	*	***	***	***	***
Purchase price	*	*	***	***	**
Accuracy, speed	*	**	*	**	***
Regulating dynamic	*	*	*	*	***
Communication	*	*	*	***	***

* = good, **=average, ***=excellent

P1V-M - Robust Air Motors

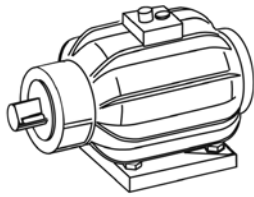

Air motors have much smaller installation dimensions than corresponding electric motors.

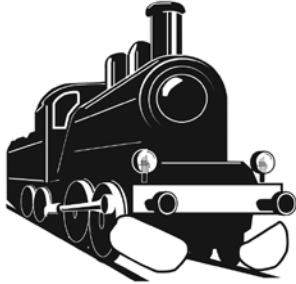

Air motors can be loaded until they stall, without damage. They are designed to be able to withstand the toughest heat, vibration, impact etc.



Air motors can be stopped and started continually without damage.

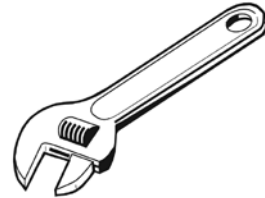

The simple design principle of air motors makes them very easy to service.



The weight of an air motor is several times less than corresponding electric motors.

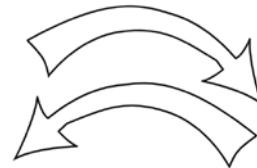

The motors are reversible as standard.

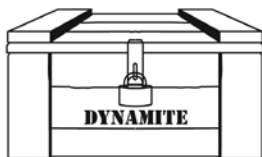

Air motors can be used in the harshest environments.



The reliability of air motors is very high, thanks to the design and the low number of moving parts.

P1V-M - Robust Air Motors



Robust Air Motors

P1V-M is a series of air motors, with planetary gearbox and motor made of grey casted iron. Its robustness makes it suitable for all normal air motor applications.

The range contains three different sizes with power ratings of 200, 400, 600, 900 and 1200 Watts,

The motor and gearbox are built to be extremely strong, making the motors suitable for applications requiring considerable robustness. The gearbox is of the planetary type, permanently lubricated with grease. The flange mounting is cast as an integral part of the case, and give, together with the foot bracket, plenty of opportunity for simple and robust installation.

A new design principle has made service activities quicker and easier than for any comparable motor. Servicing involves loosening the screws holding the rear piece to the motor, removing the worn vanes from the back and inserting the new vanes.

Unlike traditional air motors, there is no need to fully open the P1V-M for servicing, making the process much easier.

Principles of air motor functioning

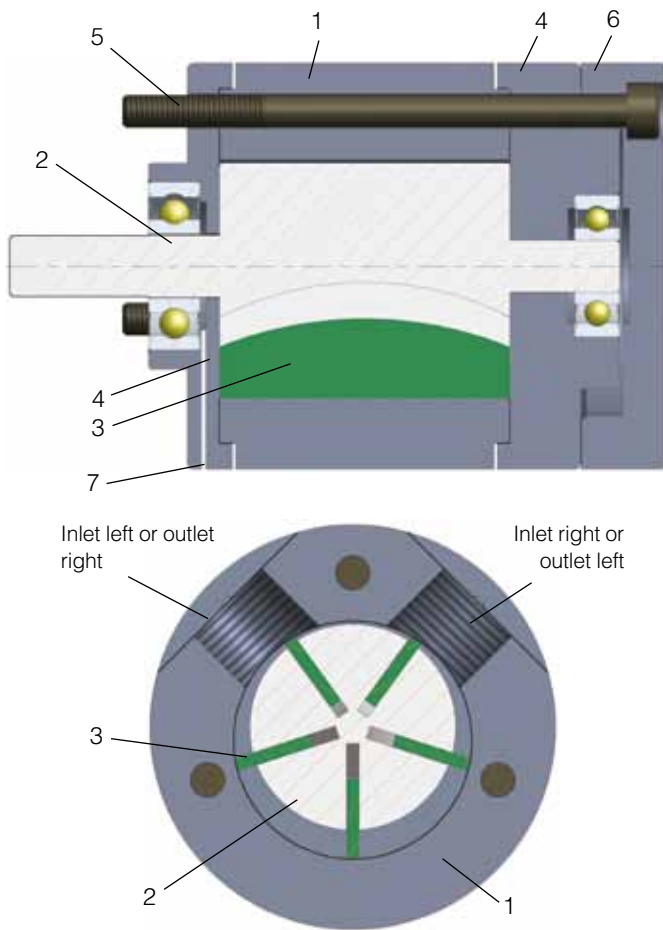

- 1 Rotor cylinder
- 2 Rotor
- 3 Vanes
- 4 End piece with bearing
- 5 Mounting screw for motor
- 6 Removable rear piece
- 7 Pressure unloading

Torque, power and air consumption graphs

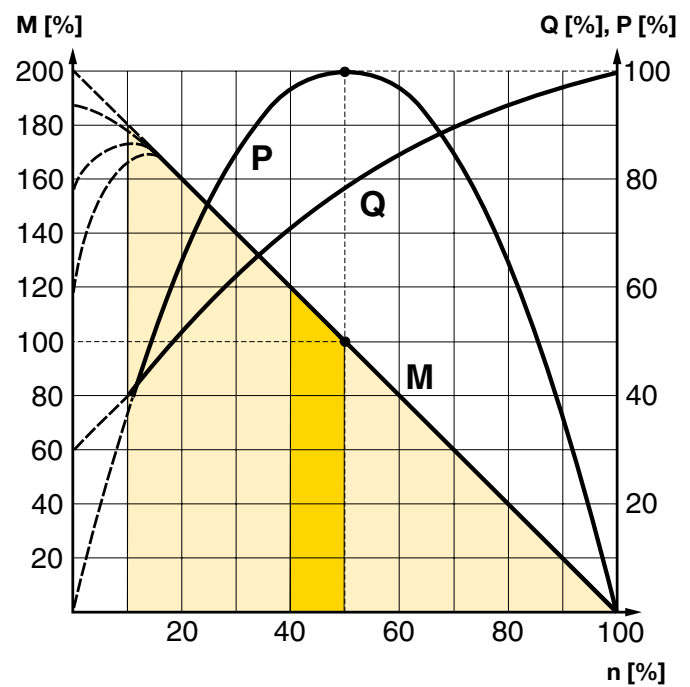

The curve is for 6 bar
P = power **Q = air consumption**
M = torque **n = speed**

- Possible working range of motor.**
- Optimum working range of motor.**
 Higher speeds = more vane wear
 Lower speeds with high torque = more gearbox wear

There are a number of designs of air motors. Parker has chosen to use the vane rotor design, because of its simple design and reliable operation. The small external dimensions of vane motors make them suitable for all applications.

The principle of the vane motor is that a rotor with a number of vanes is enclosed in a rotor cylinder. The motor is supplied with compressed air through one connection and air escapes from the other connection. The air pressure always bears at right angles against a surface. This means that the torque of the motor is a result of the vane surfaces and the air pressure. a family of curves as above, from which torque, power and air consumption can be read off as a function of speed. Power is zero when the motor is stationary and also when running at free speed (100%) with no load. Maximum power (100%) is normally developed when the motor is braked to approximately half the free speed (50%).

Torque at free speed is zero, but increases as soon as a load is applied, rising linearly until the motor stalls. As the motor can stop with the vanes in various positions, it is not possible to specify an exact starting torque. However, a minimum starting torque is shown in all tables.

Air consumption is greatest at free speed, and decreases with decreasing speed, as shown in the above diagram.

Choosing the correct air motor for your application**① Which drive principle of the air motor is suitable for your application?**

- Air vane motor are suitable for regular operating cycles, speed is very small e.g. 16 rpm
- Tooth gear air motor or turbines are more suitable for continuous operation, 24 hours non-stop, speed is in a upper range, up to 140,000 rpm
- Oil free operation is often an option for these three principles of air motors.

② Which motor materials are suitable for your application?

- Will the air motor work in a normal production area
- Or in a paper industry
- Or in the food processing industry, in contact or not with food
- Or in underwater usage
- Or in the medical, pharmaceutical industries
- Or in potentially explosive areas
- Others, please describe your environment

③ How do you calculate the motor power taking the application conditions into consideration?

1. Which rotational direction? Clockwise, anti-clockwise, reversible?
2. Air pressure working range? Which air class quality is available?
3. Which torque and which speed under load do you expect to obtain?
4. Calculate the basic power with the formula

$$P = M \times n / 9550 \text{ with } P \text{ power output in kW, } M \text{ nominal torque in Nm, } n \text{ nominal speed in rpm}$$

5. Check performance data of air motors in our catalogues. Note that all data is at 6 bar in the inlet of the air motor, max 3 meters for tubes and oil lubricated operations.
6. To adapt the difference of air pressure with your operation conditions, please check graphs in our catalogues and how to do it.
7. or you can adapt the need of air to fit your operation conditions by throttling the outlet flow in the air motor you will reduce speed without loss of torque.
8. Check if you need an oil free or not working operation. 1 to 2 drops of oil per cube meter are needed to optimize performance and life time of air motors. Oil free operation will decrease by 10 to 15% the performance of air motors.

④ How do you integrate your air motor in your system?

- In which position is the air motor used?
- Do you need to use a brake?
- Do you want to use your own gear box and put it somewhere else in the machine?
- Do you need extra components like fittings, tubes, valves and FRLs?

⑤ How do you ensure a long life and high performance of the air motor?

- Ensure you air quality is in accordance with our specifications, oil or oil free lubrication operations.
- Keep the recommended maintenance intervals

⑥ How do you determine the purchasing and running costs after the air motor installation?

- Keep same level of your air quality.

Introduction

The performance of an air motor is dependent on the inlet pressure. At a constant inlet pressure, air motors exhibit the characteristic linear output torque / speed relationship. However, by simply regulating the air supply, using the techniques of throttling or pressure regulation, the output of an air motor can easily be modified. The most economical operation of an air motor (least wear, least air consumption, etc.) is reached by running close to nominal speed. By torque of $M = 0$, the maximum speed (idle speed) is reached. Shortly before standstill ($n = 0$), the air motor reaches its maximum torque ($M_{max} = 2 \times M_o$). At nominal speed (n_n), for example in the middle of the speed range, air motor reaches its maximum power output (P_{max}).

Energy Efficiency

A pneumatic motor achieves its maximum power when it is operating as close as possible to its rated speed (50% of the rated idle speed). The energy balance is best in this area, because the compressed air is used efficiently.

Air pressure correction factors

To adapt the difference of air pressure with your operation conditions

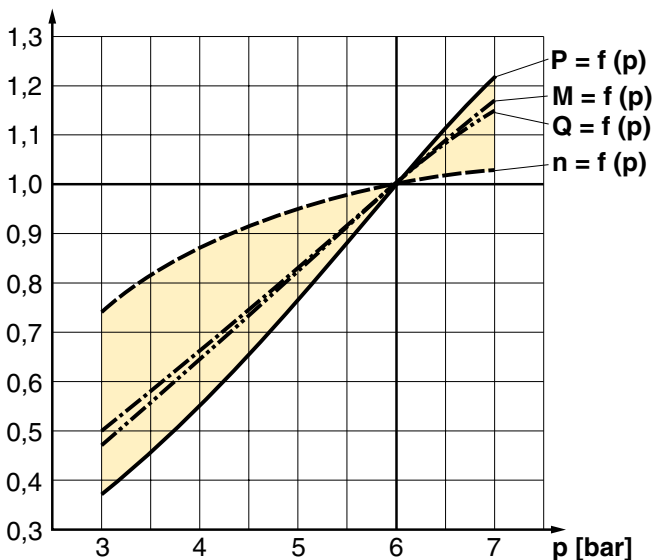

P = Power, M = Torque, Q = Air consumption, N = Speed

Pressure (p) bar / PSI	Power (P) %	Speed (n) %	Torque (M) %	Air Consumpt. (Q) %
7 / 99	121	103	117	117
6 / 85	100	100	100	100
5 / 71	77	95	83	83
4 / 57	55	87	67	67
3 / 42	37	74	50	50

All catalogue data and curves are specified at a supply pressure of 6 bar to the motor. This diagram shows the effect of pressure on speed, specified torque, power and air consumption. Start off on the curve at the pressure used and then look up to the lines for power, torque and air consumption. Read off the correction factor on the Y axis for each curve and multiply this by the specified catalogue data in the table, or data read from the torque and power graphs.

Example: at 4 bar supply pressure, the power is only 0.55 x power at 6 bar supply pressure. This example shows how strongly power falls if supply pressure is reduced. You must therefore ensure that the motor is supplied through pipes of sufficient diameter to avoid pressure drop.

The speed and torque can also be regulated by installing a pressure regulator in the inlet pipe. This means that the motor is constantly supplied with air at lower pressure, which means that when the motor is braked, it develops a lower torque on the output shaft.

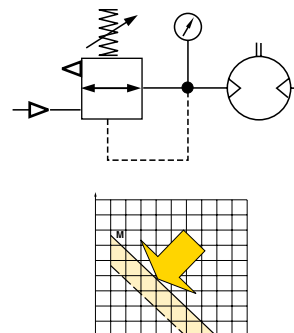

Pressure regulation at motor inlet.

Theoretically torque curve change caused by pressure change

Speed regulation, air flow reduction

Every size reduction or restriction on the air line, whether of the supply hose itself or fittings, before the air motor affects the amount of the supplied air. By throttling you reduce the speed of your motor and simultaneously, the required torque. That means that you reduce the motor performance. The most common way to reduce the speed of a motor is to install a flow control valve in the air outlet, you can set the speed without loss of the torque. When the motor is used in applications where it must reverse and it is necessary to restrict the speed in both directions, flow control valves with by-pass should be used in both directions. If the inlet air is restricted, the air supply is restricted and the free speed of the motor falls, but there is full pressure on the vanes at low speeds. This means that we get full torque from the motor at low speeds despite the low air flow. Since the torque curve becomes "steeper", this also means that we get a lower torque at any given speed than would be developed at full air flow. The benefit of throttling the inlet is that air consumption is reduced, whereas throttling the exhaust air maintains a slightly higher starting torque.

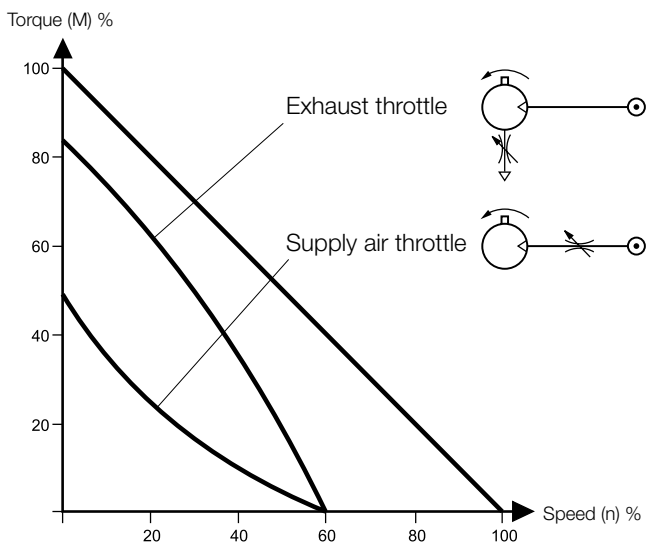

Throttling

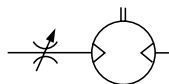

Supply or exhaust throttling, non-reversible motor

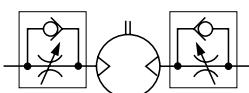

Supply throttling, reversible motor

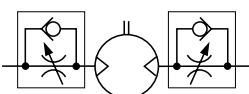

Exhaust throttling, reversible motor

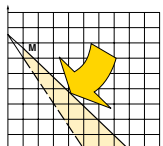

Theoretically torque curve change caused by throttling

Component choice for air supply

Direction of motor rotation

The direction of rotation of reversible motors is obtained by supplying inlet L or inlet R with compressed air. The motor can be stopped and started continually without damage occurring.



Reversible means in both directions.

Compressed air quality

Oil and oil mist are avoided whenever possible to ensure a clean work environment. In addition, purchasing, installation and maintenance of oil equipment can be expensive. All users in all industries now try to avoid using components which have to be lubricated. The P1V air motors series are equipped with vanes for intermittent lubrication free operation as standard, which is the most common application of air motors.

Dry unlubricated compressed air



If unlubricated compressed air is used, the compressed air should comply with the purity standards below in order to guarantee the longest possible overall service life. If the unlubricated compressed air has a high water content, condensation forms inside the motor, causing corrosion in all internal components. A ball bearing can be destroyed in a remarkably short time if it comes into contact with a single water droplet. For indoor use, we recommend ISO8573-1 purity class 3.4.1. To achieve this, compressors must be fitted with after coolers, oil filters, refrigerant air dryers and air filters. For indoor/outdoor use, we recommend ISO8573-1 purity class 1.2.1. To achieve this, compressors must be fitted with after coolers, oil filters, adsorption dryers and dust filters.

Oil mist



If oil mist is used (approx. 1 drop of oil per m³ of compressed air), the oil not only acts as a lubricant but also protects against corrosion. This means that compressed air with a certain water content may be used without causing corrosion problems inside the motor. ISO8573-1 purity class 3.-.5 may be used without difficulty. The following oils are recommended for use in the food stuffs industry: Shell Cassida Fluid HF 32 or Klüberoil 4 UH 1-32

ISO 8573-1 purity classes

Quality class	Contaminants		Water max. pressure dew point (°C)	Oil max. concentration (mg.m ³)
	particle size (µm)	max. concentration (mg/m ³)		
1	0.1	0.1	-70	0.01
2	1	1	-40	0.1
3	5	5	-20	1.0
4	15	8	+3	5.0
5	40	10	+7	25
6	-	-	+10	-

For example: compressed air to purity class 3.4.3. This means a 5 µm filter (standard filter), dew point +3°C (refrigerant cooled) and an oil concentration of 1,0 mg oil/m³ (as supplied by a standard compressor with a standard filter).

Air supply

Since the supply pressure at the air motor inlet port is of considerable importance for obtaining the power, speed and torque quoted in the catalogue, the recommendations below should be observed.

The following data must be complied with:

- Supply pressure: 7 bar
- Regulator pressure setting: 6.7 bar
- Pipe length between air treatment unit and valve: max. 1 m
- Pipe length valve and air motor: max 2 m

The pressure drop through the air preparation unit, pipe, valve means that 6 bar pressure is obtained at the motor supply port. Please refer to the correction diagram and factors to see what lower supply pressure means for power, speed and torque.

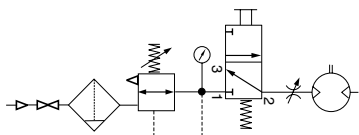
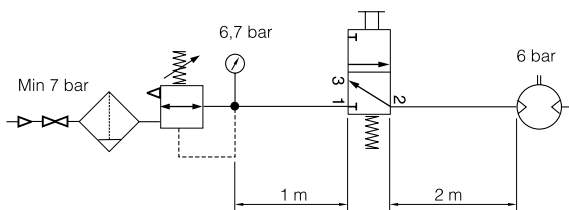

Shut-off, filtering, pressure regulation and control valve

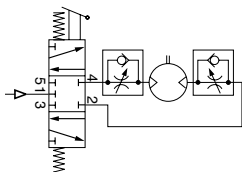

Reversible motor with 5/3 control valve

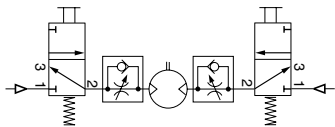

Reversible motor with two 3/2 control valves

The air with which the motor is supplied must be filtered and regulated. Directional valves are needed to provide it with air, to get the motor to rotate when we want it to. These valves can be equipped with several means of actuation, such as electric, manual and pneumatic control. When the motor is used in a non-reversible application, it is sufficient to use a 2/2 or 3/2 valve function for supply. Either one 5/3 or two 3/2 valves functions are needed for a reversible motor, to ensure that the motor receives compressed air and the residual air outlet is vented. A flow control valve can be installed in the supply pipe to regulate the motor speed if the motor is not used as a reversible motor.

One flow control valve with by-pass is needed to regulate each direction of rotation if the motor is used as a reversible motor. The built-in check valve will then allow air from the residual air outlet to escape through the outlet port in the control valve. The compressed air supply must have sufficiently large pipes and valves to give the motor the maximum power. The motor needs 6 bar at the supply port all the time. For example, a reduction of pressure to 5 bar reduces the power developed to 77% and to 55% at 4 bar!

Silencing

Exhaust silencer

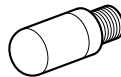

Central silencer

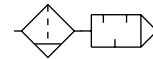

The noise from an air motor consists of both mechanical noise and a pulsating noise from the air flowing out of the outlet. The installation of the motor has a considerable effect on mechanical noise. It should be installed so that no mechanical resonance effects can occur. The outlet air creates a noise level which can amount to 115 dB(A) if the air is allowed to exhaust freely into the atmosphere. Various types of exhaust silencers are used to reduce this level. The most common type screws directly onto the exhaust port of the motor. Since the motor function causes the exhaust air to pulsate, it is a good idea to allow the air to exhaust into some kind of chamber first, which reduces the pulsations before they reach the silencer. The best silencing method is to connect a soft plastic hose to a large central silencer with the largest possible area, to reduce the speed of the out-flowing air as far as possible.

NOTE! Remember that if a silencer which is too small or is blocked, generates back pressure on the outlet side of the motor, which reduces the motor power.

CE marking

The air motors are supplied as “Components for installation” – the installer is responsible for ensuring that the motors are installed safely in the overall system. Parker Pneumatic guarantees that its products are safe, and as a supplier of pneumatic equipment we ensure that the equipment is designed and manufactured in accordance with the applicable EU directive.

Most of our products are classed as components as defined by various directives, and although we guarantee that the components satisfy the fundamental safety requirements of the directives to the extent that they are our responsibility, they do not usually carry the CE mark.

The following are the currently applicable directives:

- Machinery Directive(essential health and safety requirements relating to the design and structure of machines and safety components)
- EMC Directive
- Simple Pressure Vessels Directive
- Low Voltage Directive
- ATEX Directive (ATEX = ATmosphere EXplosive)

Torque, power and air consumption graphs

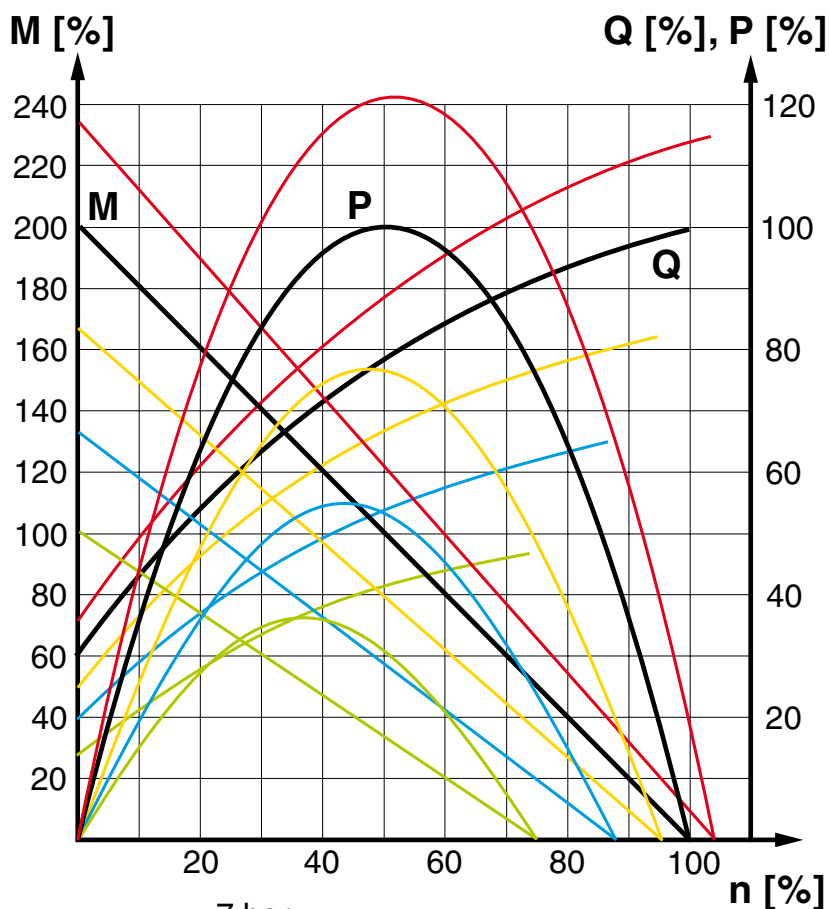

- 7 bar
- 6 bar
- 5 bar
- 4 bar
- 3 bar

P = power	Q = air consumption
M = torque	n = speed

The curves in this graph are a combination of the torque, power and air consumption graphs. The values from the correction diagram have also been used for the curves for the different pressure values. The graph also shows that it is very important to ensure that the pressure supplied to the inlet port of the motor is correct, in order to allow the motor to work at maximum capacity. If the valve supplying a large motor is too small or if the supply line is underspecified, the pressure at the inlet port may be so low that the motor is unable to do its work. One solution would be to upgrade the valve and supply system, or alternatively you could replace the motor with a smaller motor with lower air consumption. The result would be increased pressure at the inlet port, which means that the smaller motor could carry out the necessary work. However, you may need to select a smaller motor with a lower free speed in order to obtain sufficient torque at the outgoing shaft.

Choice of an air motor, general

The motor to be used should be selected by starting with the torque needed at a specific spindle speed. In other words, to choose the right motor, you have to know the required speed and torque. Since maximum power is reached at half the motor's free speed, the motor should be chosen so that the point aimed at is as close as possible to the maximum power of the motor.

The design principle of the motor means that higher torque is generated when it is braked, which tends to increase the speed. This means that the motor has a kind of speed selfregulation function built in. Use the following graph to choose the correct motor size and the correct type of gear as appropriate. The graph contains the points for the maximum torque of each motor at maximum power. Put in your point on the graph and select a marked point above and to the right of the point you need.

Then check the characteristic graph of each motor to find more accurate technical data. Always select a motor where the data required is in the orange field. Also use the correction diagram to see what it would mean to use different air supply pressures or different air flow in the motor.

Tip: Select a motor which is slightly too fast and powerful, regulate its speed and torque with a pressure regulator and/or restriction to achieve the optimum working point.

Do you need any support to select the right air motor, please feel free to consult your local sales office.

Specifying air quality (purity) in accordance with ISO8573-1:2010, the international standard for Compressed Air Quality

ISO8573-1 is the primary document used from the ISO8573 series as it is this document which specifies the amount of contamination allowed in each cubic metre of compressed air.

ISO8573-1 lists the main contaminants as Solid Particulate, Water and Oil. The purity levels for each contaminant are shown separately in tabular form, however for ease of use, this document combines all three contaminants into one easy to use table.

ISO8573-1:2010 CLASS	Solid Particulate			Mass Concentration mg/m ³	Water		Oil
	Maximum number of particles per m ³				Vapour Pressure Dewpoint	Liquid g/m ³	Total Oil (aerosol liquid and vapour) mg/m ³
	0,1 - 0,5 micron	0,5 - 1 micron	1 - 5 micron				
0	As specified by the equipment user or supplier and more stringent than Class 1						
1	≤ 20 000	≤ 400	≤ 10	-	≤ -70 °C	-	0,01
2	≤ 400 000	≤ 6 000	≤ 100	-	≤ -40 °C	-	0,1
3	-	≤ 90 000	≤ 1 000	-	≤ -20 °C	-	1
4	-	-	≤ 10 000	-	≤ +3 °C	-	5
5	-	-	≤ 100 000	-	≤ +7 °C	-	-
6	-	-	-	≤ 5	≤ +10 °C	-	-
7	-	-	-	5 - 10	-	≤ 0,5	-
8	-	-	-	-	-	0,5 - 5	-
9	-	-	-	-	-	5 - 10	-
X	-	-	-	> 10	-	> 10	> 10

Specifying air purity in accordance with ISO8573-1:2010

When specifying the purity of air required, the standard must always be referenced, followed by the purity class selected for each contaminant (a different purity class can be selected for each contamination if required).

An example of how to write an air quality specification is shown below:

ISO 8573-1:2010 Class 1.2.1

ISO 8573-1:2010 refers to the standard document and its revision, the three digits refer to the purity classifications selected for solid particulate, water and total oil. Selecting an air purity class of 1.2.1 would specify the following air quality when operating at the standard's reference conditions :

Class 1 - Particulate

In each cubic metre of compressed air, the particulate count should not exceed 20,000 particles in the 0.1 - 0.5 micron size range, 400 particles in the 0.5 - 1 micron size range and 10 particles in the 1 - 5 micron size range.

Class 2 - Water

A pressure dewpoint (PDP) of -40°C or better is required and no liquid water is allowed.

Class 1 - Oil

In each cubic metre of compressed air, not more than 0.01mg of oil is allowed. This is a total level for liquid oil, oil aerosol and oil vapour.

ISO8573-1:2010 Class zero

- **Class 0 does not mean zero contamination.**
- **Class 0 requires the user and the equipment manufacturer to agree contamination levels as part of a written specification.**
- **The agreed contamination levels for a Class 0 specification should be within the measurement capabilities of the test equipment and test methods shown in ISO8573 Pt 2 to Pt 9.**
- **The agreed Class 0 specification must be written on all documentation to be in accordance with the standard.**
- **Stating Class 0 without the agreed specification is meaningless and not in accordance with the standard.**
- **A number of compressor manufacturers claim that the delivered air from their oil-free compressors is in compliance with Class 0.**
- **If the compressor was tested in clean room conditions, the contamination detected at the outlet will be minimal. Should the same compressor now be installed in typical urban environment, the level of contamination will be dependent upon what is drawn into the compressor intake, rendering the Class 0 claim invalid.**
- **A compressor delivering air to Class 0 will still require purification equipment in both the compressor room and at the point of use for the Class 0 purity to be maintained at the application.**
- **Air for critical applications such as breathing, medical, food, etc typically only requires air quality to Class 2.2.1 or Class 2.1.1.**
- **Purification of air to meet a Class 0 specification is only cost effective if carried out at the point of use.**

New Technology

The P3X Lite air preparation system is constructed from ultra light weight technopolymers instead of the traditional aluminium or zinc die cast, this means that is up to 45% lighter than conventional units.

This non-metal construction also means that the P3X Lite is corrosion free enabling it to be used in harsh industrial environments where anti freeze or aggressive synthetic oils are present.

The use of technopolymers in the design of P3X Lite has facilitated a universal body design, this has resulted in reducing the number of variants required to cover the full spectrum of applications. This can dramatically lower logistic costs and simplify stock holding for customers making the P3X Lite a very cost effective solution.



New Nano Mist Technology, New Lubricator Concept. Self-Adjusting.

With conventional lubricators, only the oil volume per time unit can be adjusted. If the demand changes, the quantity dispensed still remains constant.

The P3X Lite lubricator concept sets new benchmarks here. For the first time, the oil volume is automatically adjusted to the flow rate. This ensures that there is neither too little nor too much oil in the system, which leads to clear economic and ecological advantages. In addition, with conventional systems, the distance between the lubricator and the equipment has to be less than 8 meters. With larger distances, the dispensed oil is deposited as a wall flow. The new lubricator principle of the P3X Lite allows for distances of up to 40 meters. This opens up new scope for the design of even more efficient production systems.

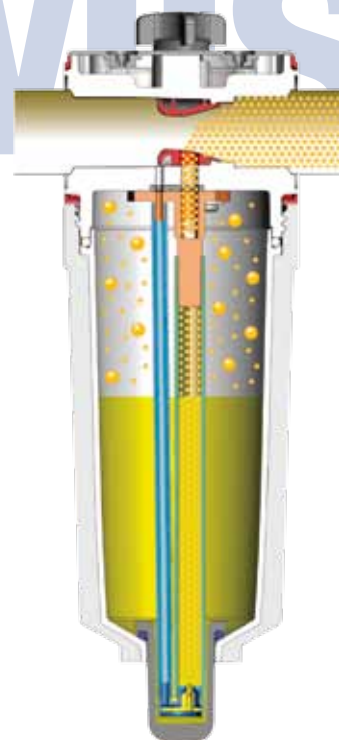

Technical data

Note: All technical data are based on a working pressure of 6 bar and with oil.
For oil-free performances are -10 to 15% lower than data in charts.
Speed tolerance accuracy in between clock and anti-clockwise directions is $\pm 10\%$.

Air motor size & type	P1V-M020	P1V-M040	P1V-M060	P1V-M090	P1V-M120
Nominal power (watts)	200	400	600	900	1200
Working pressure (bar)	3 to 7, 6 in explosive atmosphere				
Working temperature (°C)	-20 to +110				
Ambient temperature (°C)	-20 to +40 in explosive atmosphere				
Air flow required (l/min)	300	600	900	2200	2600
Min pipe ID, inlet (mm)	10	12	13	13	13
Min pipe ID, outlet (mm)	10	12	13	13	13
Choice of treatment unit: recommended min air flow (l/min) at p1 7.5 bar and 0.8 bar pressure drop					
	330	660	990	2500	2900
Choice of valve: recommended min nominal air flow (l/min) at p1 6 bar and 1 bar pressure drop					
	360	720	1080	2800	3200
Medium	40 μ m filtered, oil mist or dry unlubricated compressed air				
Oil free operation, indoor	ISO8573-1 purity class 3.4.1				
Oil free operation, outdoor	ISO8573-1 purity class 1.2.1				
Oil operation	1-2 drop(s) per cube meter, ISO8573-1 purity class 3.-.5				
Recommended oil	Foodstuffs industry Klüber oil 4 UH1- 32 N				
Sound level free outlet (dB(A))	107	107	107	120	120
With outlet silencer (dB(A))	97	98	99	81	81

Note: Sound levels are measured at free speed with the measuring instrument positioned 1 meter away from the air motor at an height of 1 meter.

Material specification

Air motor size & type	P1V-M020	P1V-M040	P1V-M060	P1V-M090	P1V-M120
	Without gear box				
Motor housing	Cast iron, synthetic paint, grey color				
Shaft	Hardened steel				
Key	Hardened steel				
External seal	NBR				
Internal steel parts	High grade steel				
Motor lubrication	Bearings: grease				
Vanes	Patented, no data				
	With gear box				
Planetary gearbox	Steel / cast iron, synthetic paint, grey color				
Shaft	Hardened steel				
Key	Hardened steel				
External seal	NBR				
Internal steel parts	High grade steel				
Gearbox lubrication	Grease, Shell Cassida RLS2				

Choice of an air motor

Nominal torque [Nm]

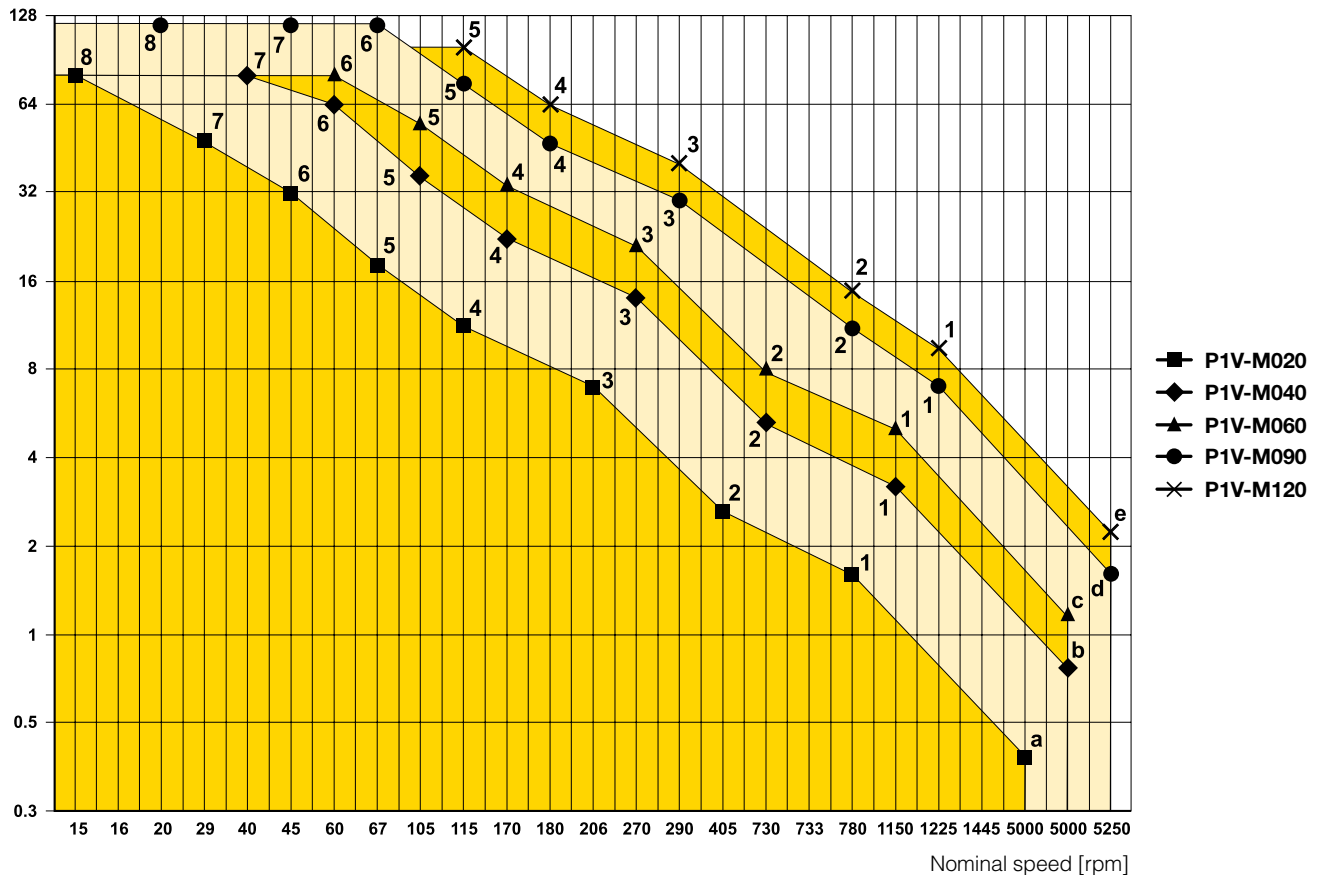

The motor to be used should be selected by starting with the torque needed at a specific shaft speed. In other words, to choose the right motor, you have to know the required speed and torque. Since maximum power is reached at half the motor's free speed, the motor should be chosen so that the operating point is as close as possible to the maximum power of the motor.

The design principle of the motor means that higher torque is generated when it is braked, which tends to increase the speed, etc. This means that the motor has a kind of speed self-regulation function built in.

Use the above graph to choose the correct motor size. The graph contains the points for the maximum torque of each motor at maximum output. Add your operating point to the graph, then select a marked point above and to the right of your point.

Then use the correct working diagram of the chosen motor to get more detailed technical data. Always select a motor whose requisite technical data are in the shaded area. Also use the correction diagram to find out what operation with different supply pressures would mean for the motor.

Tip: Select a motor which is slightly too fast and powerful, then regulate its speed and torque with a pressure regulator and/or throttle to achieve the optimum working point.

Air motors in diagram above

- | | | | |
|-----|---------------|-----|---------------|
| ■ a | P1V-M020B0A00 | ▲ 1 | P1V-M060C0230 |
| ◆ b | P1V-M040B0A00 | ▲ 2 | P1V-M060C0146 |
| ▲ c | P1V-M060B0A00 | ▲ 3 | P1V-M060C0054 |
| ● d | P1V-M090B0A00 | ▲ 4 | P1V-M060C0034 |
| ✕ e | P1V-M120B0A00 | ▲ 5 | P1V-M060C0021 |
| | | ▲ 6 | P1V-M060C0012 |
| ■ 1 | P1V-M020C0230 | ● 1 | P1V-M090C0245 |
| ■ 2 | P1V-M020C0146 | ● 2 | P1V-M090C0156 |
| ■ 3 | P1V-M020C0054 | ● 3 | P1V-M090C0058 |
| ■ 4 | P1V-M020C0034 | ● 4 | P1V-M090C0036 |
| ■ 5 | P1V-M020C0021 | ● 5 | P1V-M090C0023 |
| ■ 6 | P1V-M020C0012 | ● 6 | P1V-M090C0013 |
| ■ 7 | P1V-M020C0008 | ● 7 | P1V-M090C0009 |
| ■ 8 | P1V-M020C0003 | ● 8 | P1V-M090C0004 |
| ◆ 1 | P1V-M040C0230 | ✕ 1 | P1V-M120C0245 |
| ◆ 2 | P1V-M040C0146 | ✕ 2 | P1V-M120C0156 |
| ◆ 3 | P1V-M040C0054 | ✕ 3 | P1V-M120C0058 |
| ◆ 4 | P1V-M040C0034 | ✕ 4 | P1V-M120C0036 |
| ◆ 5 | P1V-M040C0021 | ✕ 5 | P1V-M120C0023 |
| ◆ 6 | P1V-M040C0012 | | |
| ◆ 7 | P1V-M040C0008 | | |

NOTE! All technical data are based on a working pressure of 6 bar and with oil. For oil-free performances are -10 to 15% lower. Speed tolerance accuracy +-10%



II 2 GD c IIC T4 (130°C)

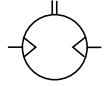

Robust motor reversible with keyed shaft, flange

Max power	Free speed*	Nominal speed	Nominal torque	Min start torque	Air consumption at max power	Conn.	Min pipe ID	Weight	Order code
kW	rpm	rpm	Nm	Nm	l/s		mm	Kg	
0,200	10 000	5 000	0,38	0,57	5	G1/8	10	1,00	P1V-M020B0A00
0,400	10 000	5 000	0,76	1,10	10	G3/8	12	1,40	P1V-M040B0A00
0,600	10 000	5 000	1,10	1,70	15	G3/8	13	1,60	P1V-M060B0A00
0,900	10 500	5 250	1,60	2,40	36,7	G1/2	13	3,10	P1V-M090B0A00
1,200	10 500	5 250	2,20	3,30	43,3	G1/2	13	3,80	P1V-M120B0A00

* maximum admissible speed (idling)

P1V-M020B0A00

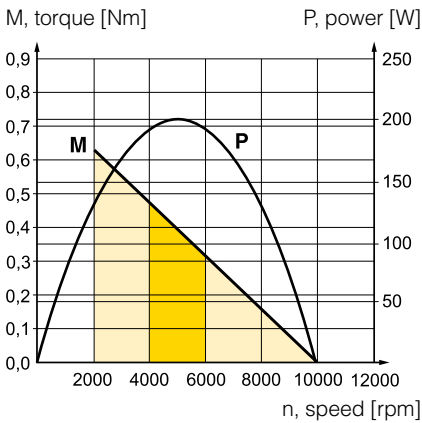

P1V-M040B0A00

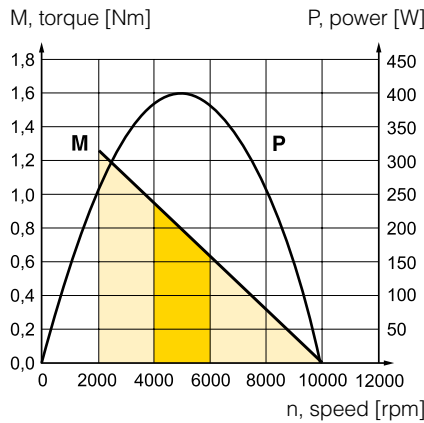

P1V-M060B0A00

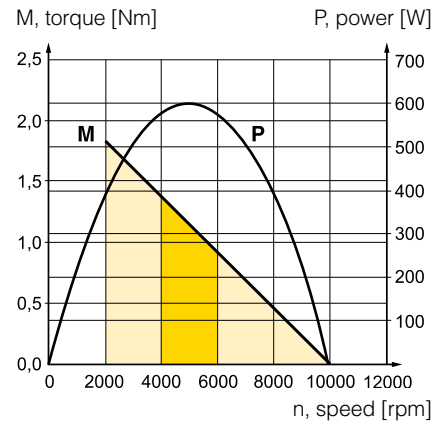

P1V-M090B0A00

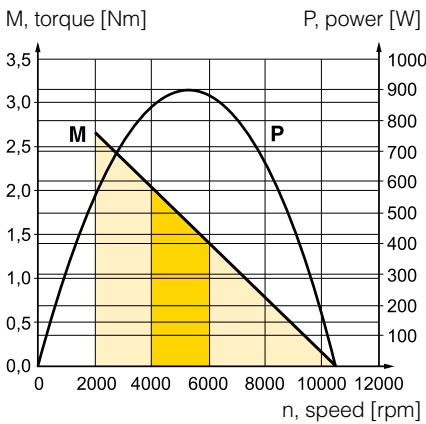

P1V-M120B0A00

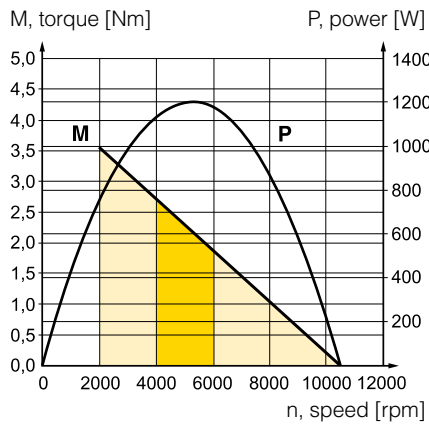

Possible working range of motor.

Optimum working range of motor.

Higher speeds = more vane wear
Lower speeds with high torque = more gearbox wear

Dimensions (mm)

Motor P1V-M020B0A00

Motor P1V-M040B0A00

Motor P1V-M060B0A00

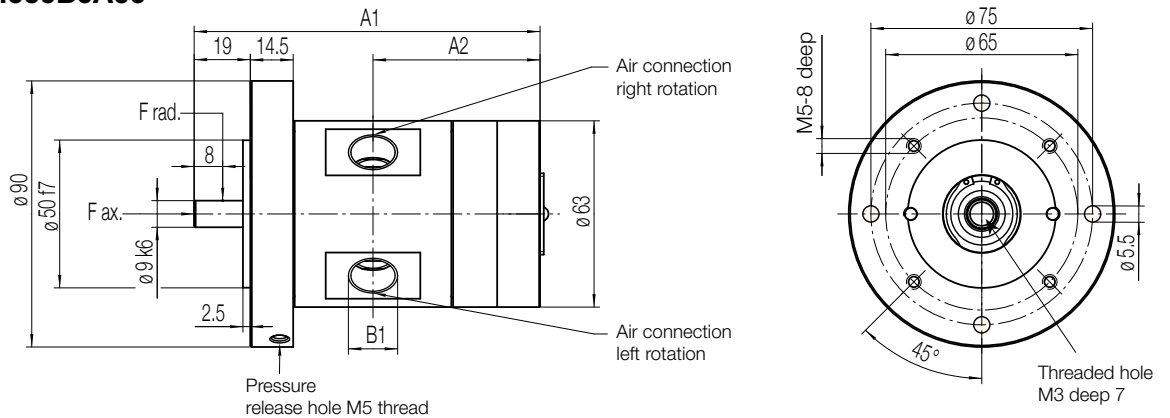

Motor P1V-M090B0A00

Motor P1V-M120B0A00

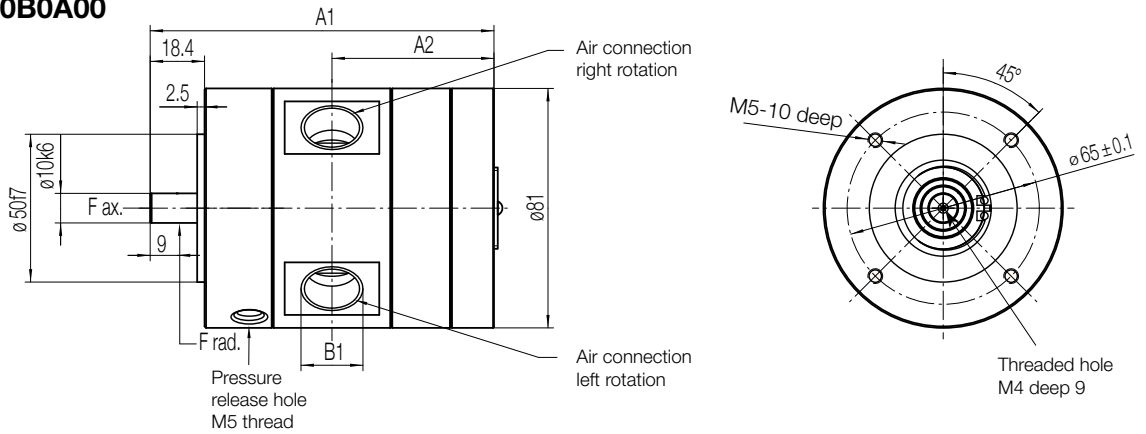

Foot bracket P1V-MF3

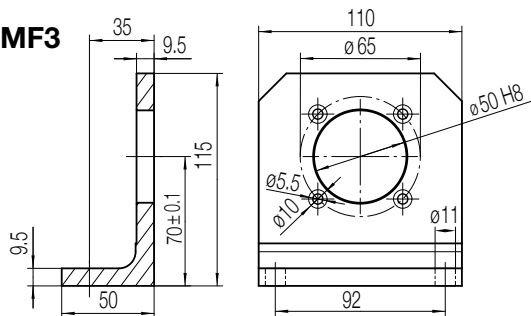

Motor type	Dimensions (mm)			Key on shaft
	A1	A2	B1	
P1V-M020B0A00	82	39	G1/8	DIN6885 A3x3x10
P1V-M040B0A00	102	49	G3/8	DIN6885 A3x3x10
P1V-M060B0A00	117	56.5	G3/8	DIN6885 A3x3x10
P1V-M090B0A00	116.3	54.8	G1/2	DIN6885 A3x3x18
P1V-M120B0A00	136.3	64.3	G1/2	DIN6885 A3x3x18

NOTE! All technical data are based on a working pressure of 6 bar and with oil. For oil-free performances are -10 to 15% lower. Speed tolerance accuracy +-10%



II 2 GD c IIC T4 (130°C)

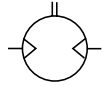

Robust reversible motor with keyed shaft, flange

Max power	Free speed*	Nominal speed	Nominal torque	Min start torque	Air consumption at max power	Conn.	Min pipe ID	Weight	Order code
kW	rpm	rpm	Nm	Nm	l/s		mm	Kg	
0,200	2 300	1 150	1,60	2,40	5	G1/8	10	2,40	P1V-M020C0230
0,200	1 460	730	2,60	3,90	5	G1/8	10	2,40	P1V-M020C0146
0,200	540	270	7,00	10,50	5	G1/8	10	2,80	P1V-M020C0054
0,200	340	170	11,20	16,80	5	G1/8	10	2,80	P1V-M020C0034
0,200	210	105	18,20	27,30	5	G1/8	10	2,80	P1V-M020C0021
0,200	120	60	31,80	47,70	5	G1/8	10	3,20	P1V-M020C0012
0,200	80	40	47,80	71,70	5	G1/8	10	3,20	P1V-M020C0008
0,200	32	16	80**	80**	5	G1/8	10	3,20	P1V-M020C0003

* maximum admissible speed (idling) / ** gear box restriction

P1V-M020C0230

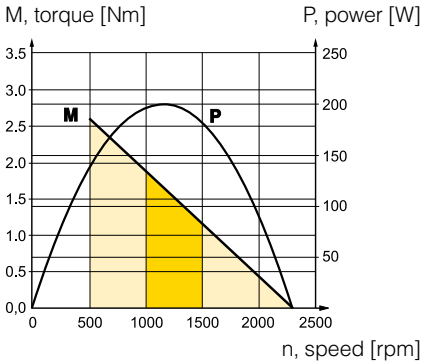

P1V-M020C0146

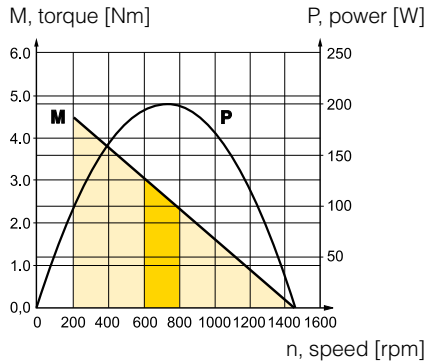

P1V-M020C0054

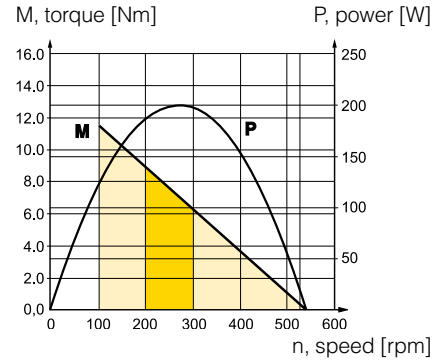

P1V-M020C0034

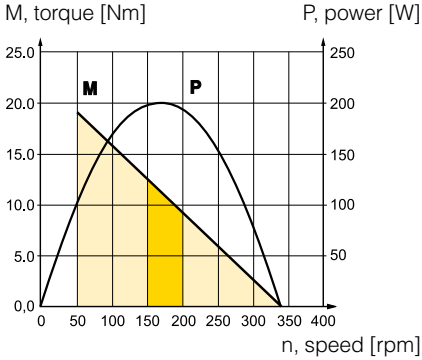

P1V-M020C0021

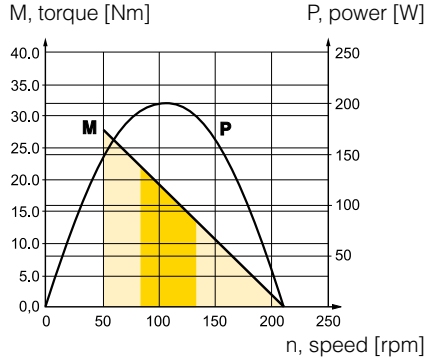

P1V-M020C0012

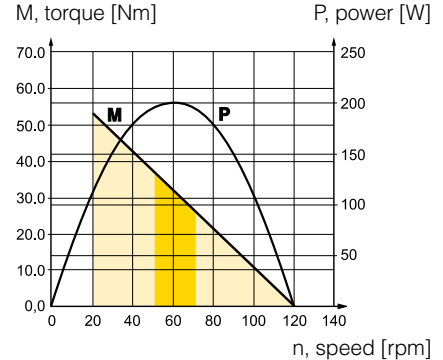

P1V-M020C0008

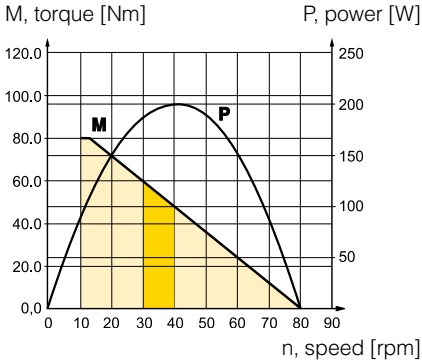

P1V-M020C0003

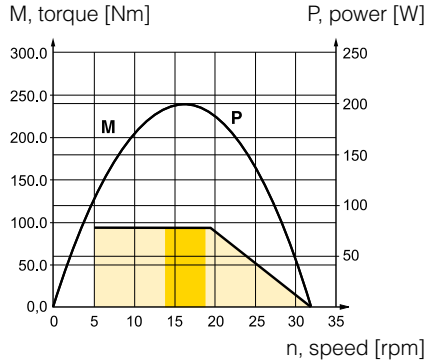

Possible working range of motor.

Optimum working range of motor.

Higher speeds = more vane wear
Lower speeds with high torque = more gearbox wear

NOTE! All technical data are based on a working pressure of 6 bar and with oil. For oil-free performances are -10 to 15% lower. Speed tolerance accuracy +-10%



II 2 GD c IIC T4 (130°C)

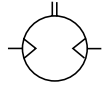

Robust reversible motor with keyed shaft, flange

Max power	Free speed*	Nominal speed	Nominal torque	Min start torque	Air consumption at max power	Conn.	Min pipe ID	Weight	Order code
kW	rpm	rpm	Nm	Nm	l/s		mm	Kg	
0,400	2 300	1 150	3,20	4,80	10	G3/8	12	2,80	P1V-M040C0230
0,400	1 460	730	5,20	7,80	10	G3/8	12	2,80	P1V-M040C0146
0,400	540	270	14,00	21,00	10	G3/8	12	3,20	P1V-M040C0054
0,400	340	170	22,40	33,60	10	G3/8	12	3,20	P1V-M040C0034
0,400	210	105	36,40	54,60	10	G3/8	12	3,20	P1V-M040C0021
0,400	120	60	63,60	80**	10	G3/8	12	3,60	P1V-M040C0012
0,400	80	40	80**	80**	10	G3/8	12	3,60	P1V-M040C0008

* maximum admissible speed (idling) / ** gear box restriction

P1V-M040C0230

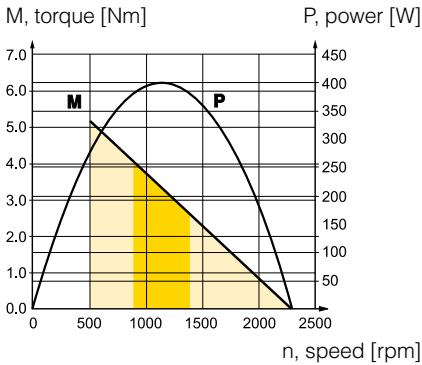

P1V-M040C0146

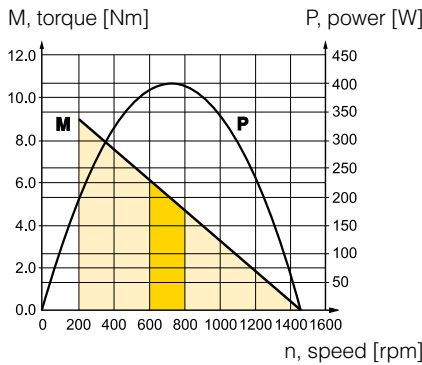

P1V-M040C0054

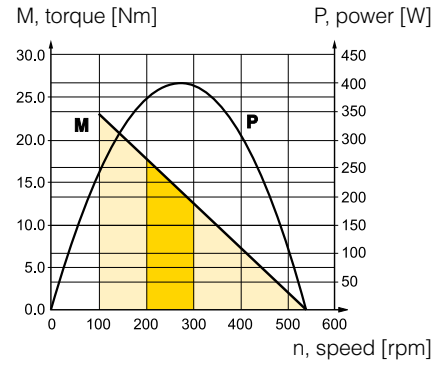

P1V-M040C0034

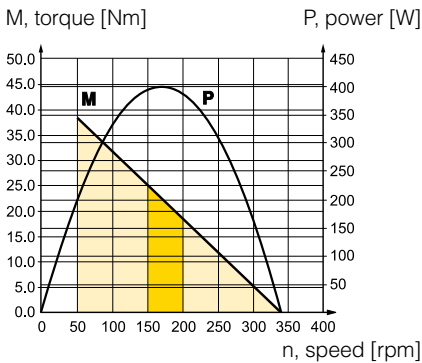

P1V-M040C0021

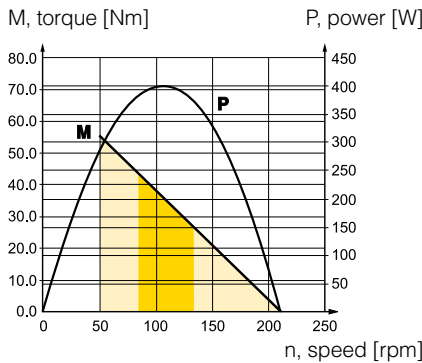

P1V-M040C0012

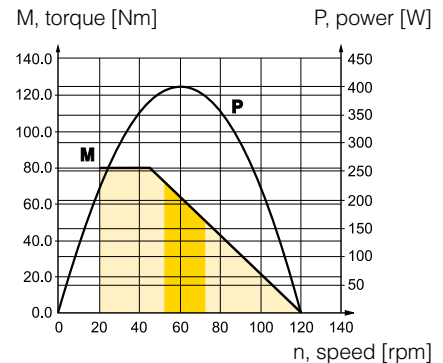

P1V-M040C0008

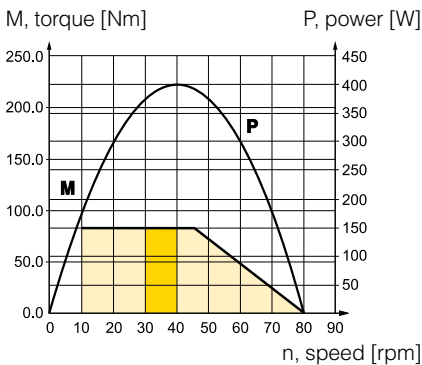

Possible working range of motor.

Optimum working range of motor.
Higher speeds = more vane wear
Lower speeds with high torque = more gearbox wear

Dimensions (mm)

Motor P1V-M040C

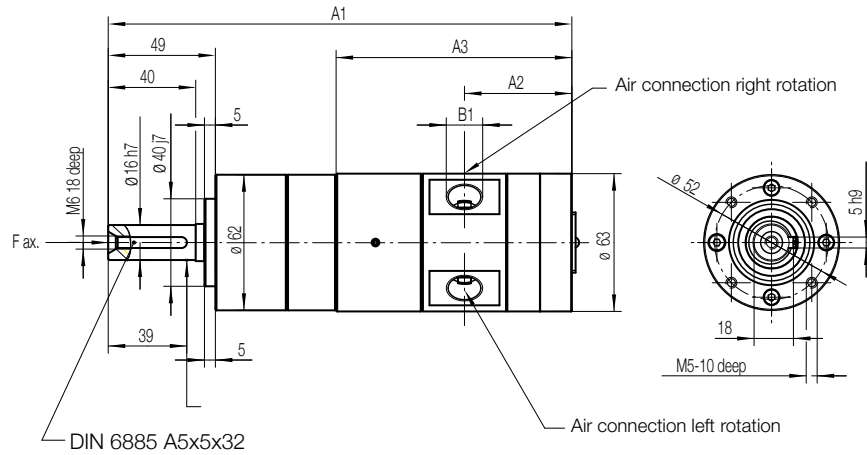

Foot bracket

P1V-MF4

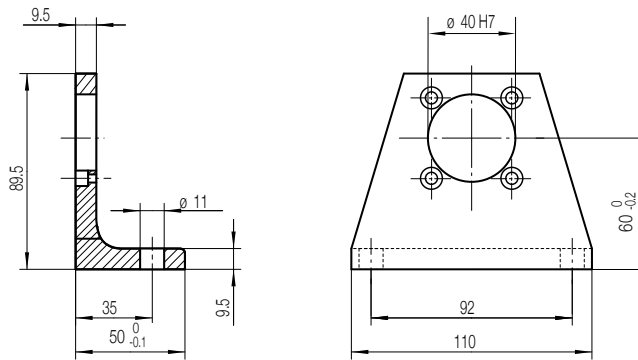

Flanges

P1V-MF8, P1V-MF9

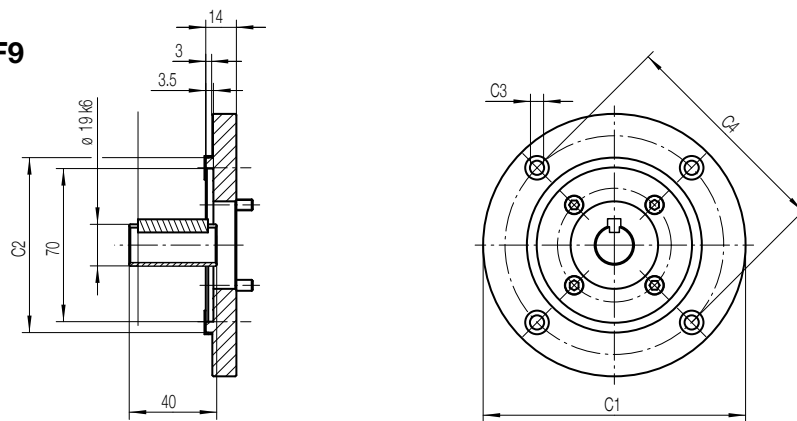

Motor size				Dimensions (mm)			
				A1	A2	A3	B1
400 watts	P1V-M040C0230	P1V-M040C0034		212.5	49	108	G3/8
	P1V-M040C0146	P1V-M040C0021	P1V-M040C0008	228.5	49	108	G3/8
	P1V-M040C0054	P1V-M040C0012		244	49	108	G3/8

Motor type	Dimensions (mm)				
	C1	C2	C3	C4	
P1V-M040C	(IEC80 B5) P1V-MF9	200	130f7	11	165
	(IEC80 B14) P1V-MF8	120	80f7	M6	100

NOTE! All technical data are based on a working pressure of 6 bar and with oil. For oil-free performances are -10 to 15% lower. Speed tolerance accuracy +-10%



II 2 GD c IIC T4 (130°C)

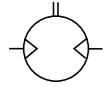

Robust reversible motor with keyed shaft, flange

Max power	Free speed*	Nominal speed	Nominal torque	Min start torque	Air consumption at max power	Conn.	Min pipe ID	Weight	Order code
kW	rpm	rpm	Nm	Nm	l/s		mm	Kg	
0,600	2 300	1 150	5,00	7,50	15	G3/8	13	3,00	P1V-M060C0230
0,600	1 460	730	7,80	11,70	15	G3/8	13	3,00	P1V-M060C0146
0,600	540	270	21,00	31,50	15	G3/8	13	3,40	P1V-M060C0054
0,600	340	170	33,60	50,40	15	G3/8	13	3,40	P1V-M060C0034
0,600	210	105	54,50	80**	15	G3/8	13	3,40	P1V-M060C0021
0,600	120	60	80**	80**	15	G3/8	13	3,80	P1V-M060C0012

* maximum admissible speed (idling) / ** gear box restriction

P1V-M060C0230

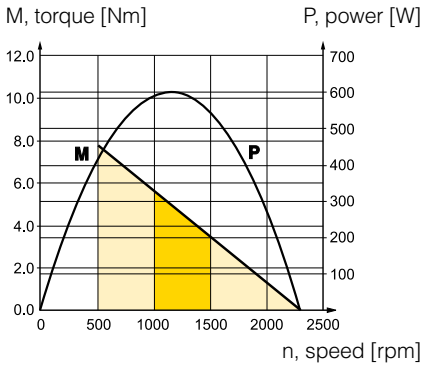

P1V-M060C0146

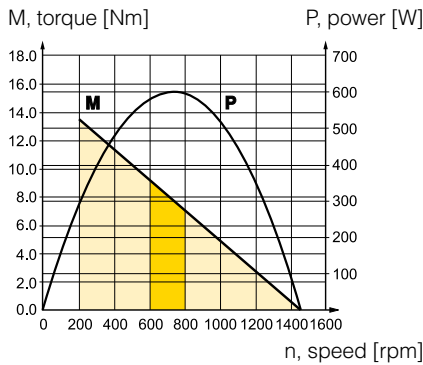

P1V-M060C0054

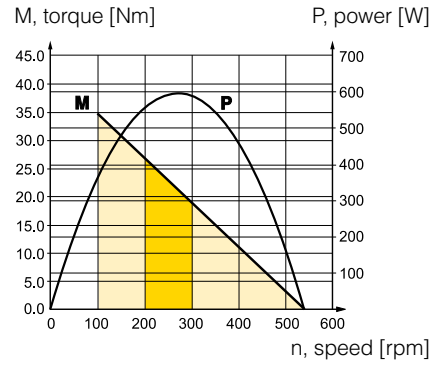

P1V-M060C0034

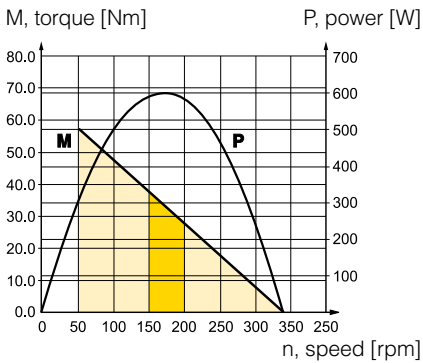

P1V-M060C0021

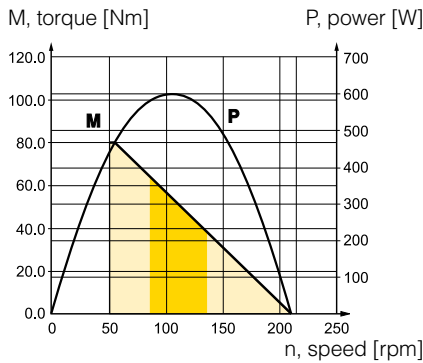

P1V-M060C0012

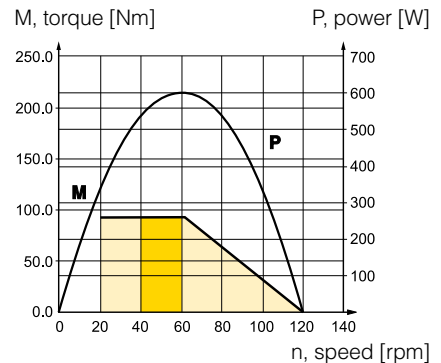

Possible working range of motor.

Optimum working range of motor.
Higher speeds = more vane wear
Lower speeds with high torque = more gearbox wear

NOTE! All technical data are based on a working pressure of 6 bar and with oil. For oil-free performances are -10 to 15% lower. Speed tolerance accuracy +-10%



II 2 GD c IIC T4 (130°C)

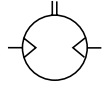

Robust motor reversible with keyed shaft, flange

Max power	Free speed*	Nominal speed	Nominal torque	Min start torque	Air consumption at max power	Conn.	Min pipe ID	Weight	Order code
kW	rpm	rpm	Nm	Nm	l/s		mm	Kg	
0,900	2 450	1 225	7,00	10,50	36,7	G1/2	13	4,90	P1V-M090C0245
0,900	1 560	780	11,00	16,50	36,7	G1/2	13	4,90	P1V-M090C0156
0,900	580	290	30,00	45,00	36,7	G1/2	13	5,60	P1V-M090C0058
0,900	360	180	47,00	71,00	36,7	G1/2	13	5,60	P1V-M090C0036
0,900	230	115	75,00	112,00	36,7	G1/2	13	5,60	P1V-M090C0023
0,900	134	67	120**	120**	36,7	G1/2	13	6,30	P1V-M090C0013
0,900	90	45	120**	120**	36,7	G1/2	13	6,30	P1V-M090C0009
0,900	40	20	120**	120**	36,7	G1/2	13	6,30	P1V-M090C0004

* maximum admissible speed (idling) / ** gear box restriction

P1V-M090C0245

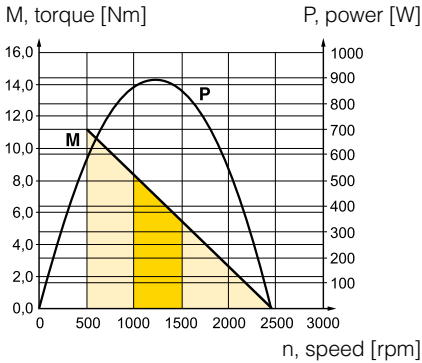

P1V-M090C0156

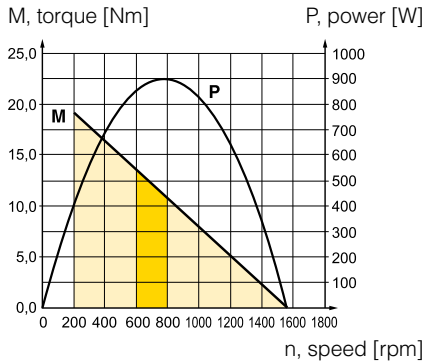

P1V-M090C0058

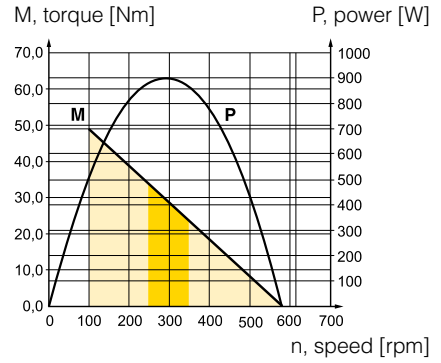

P1V-M090C0036

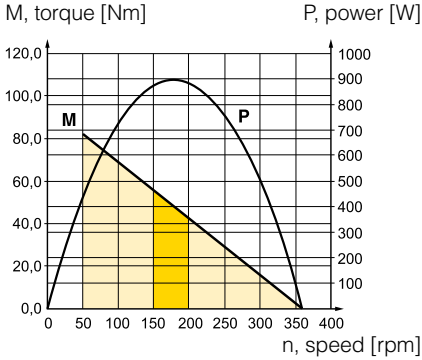

P1V-M090C0023

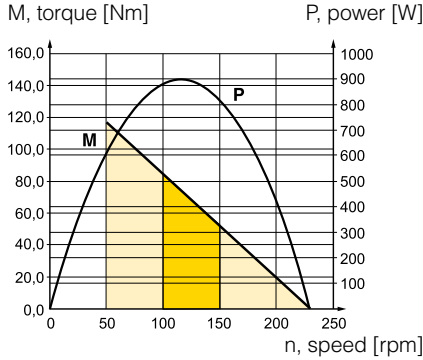

P1V-M090C0013

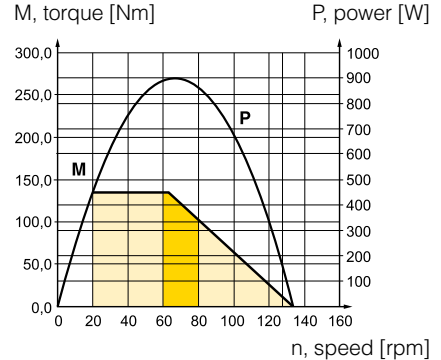

P1V-M090C0009

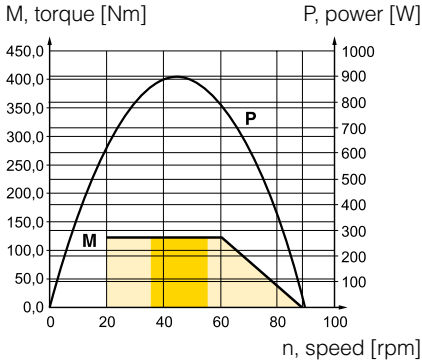

P1V-M090C0004

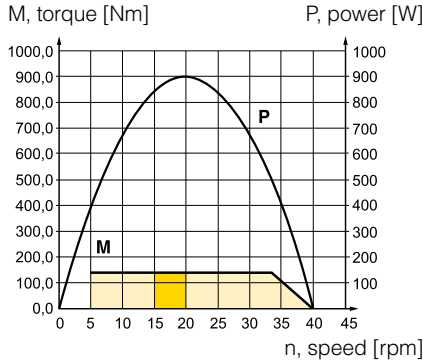

Possible working range of motor.

Optimum working range of motor.
Higher speeds = more vane wear
Lower speeds with high torque = more gearbox wear

Dimensions (mm)

Motor P1V-M090C

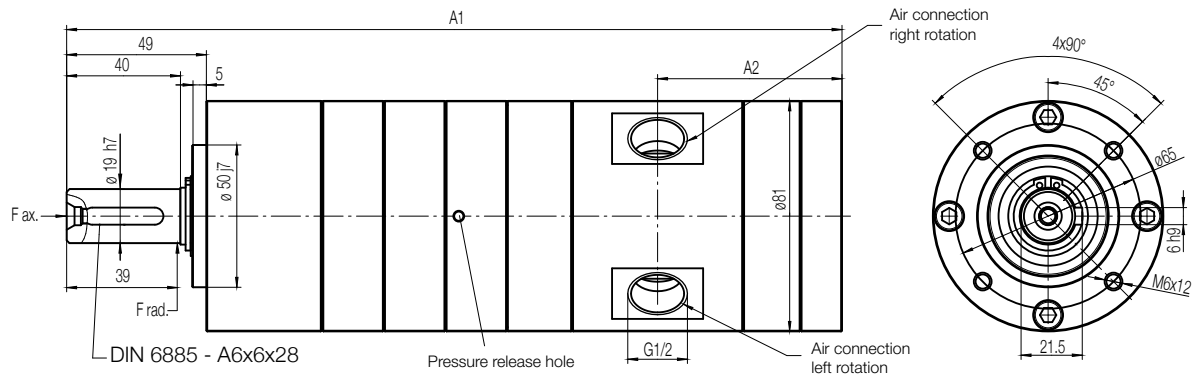

Foot bracket P1V-MF5

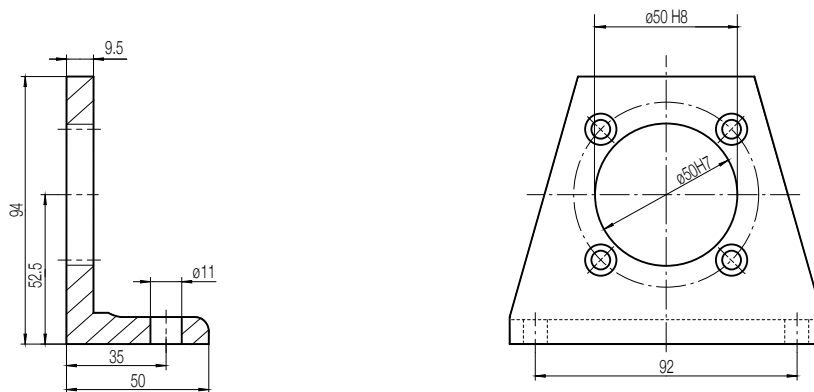

Flanges P1V-MF6, P1V-MF7

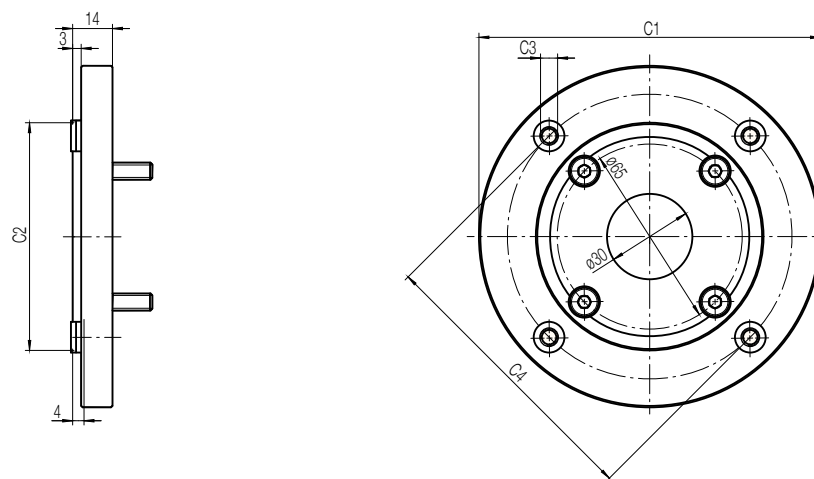

Motor size				Dimensions (mm)	
				A1	A2
900 watts	P1V-M090C0245	P1V-M090C0156		209	55
	P1V-M090C0058	P1V-M090C0036	P1V-M090C0023	231	55
	P1V-M090C0013	P1V-M090C0009	P1V-M090C0004	252.5	55

Motor type	Dimensions (mm)			
	C1	C2	C3	C4
P1V-M090C	(IEC80 B5) P1V-MF7			
	200	130f7	11	165
	(IEC80 B14) P1V-MF6			
	120	80f7	M6	100

NOTE! All technical data are based on a working pressure of 6 bar and with oil. For oil-free performances are -10 to 15% lower. Speed tolerance accuracy +-10%

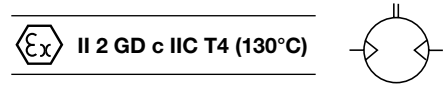

Robust motor reversible with keyed shaft, flange

Max power	Free speed*	Nominal speed	Nominal torque	Min start torque	Air consumption at max power	Conn.	Min pipe ID	Weight	Order code
kW	rpm	rpm	Nm	Nm	l/s		mm	Kg	
1,20	2 450	1 225	9,40	14,00	43,3	G1/2	13	5,60	P1V-M120C0245
1,20	1 560	780	14,70	22,00	43,3	G1/2	13	5,60	P1V-M120C0156
1,20	580	290	40,00	60,00	43,3	G1/2	13	6,30	P1V-M120C0058
1,20	360	180	63,00	94,00	43,3	G1/2	13	6,30	P1V-M120C0036
1,20	230	115	100,00	120**	43,3	G1/2	13	6,30	P1V-M120C0023

* maximum admissible speed (idling) / ** gear box restriction

P1V-M120C0245

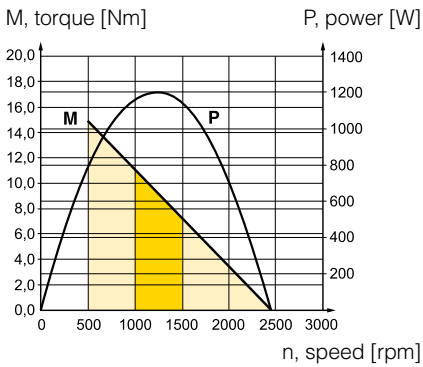

P1V-M120C0156

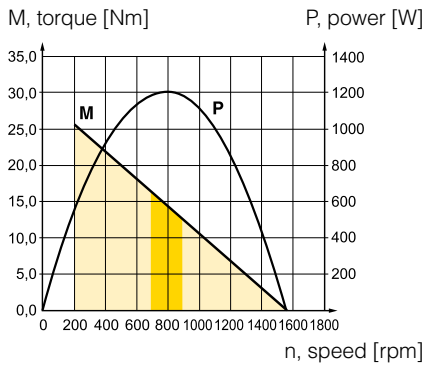

P1V-M120C0058

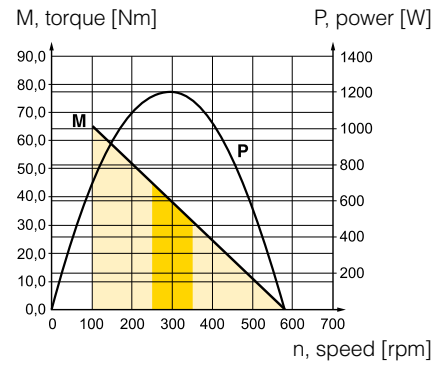

P1V-M120C0036

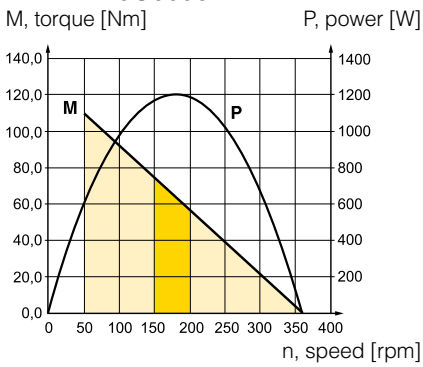

P1V-M120C0023

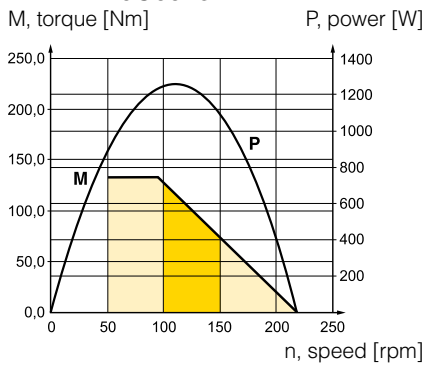

- Possible working range of motor.
 - Optimum working range of motor.
- Higher speeds = more vane wear
Lower speeds with high torque = more gearbox wear

Dimensions (mm)

Motor P1V-M120C

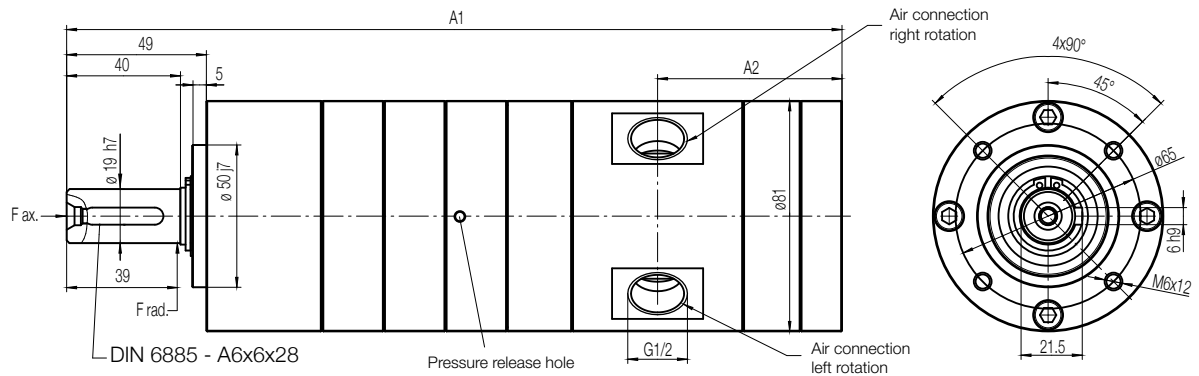

Foot bracket P1V-MF5

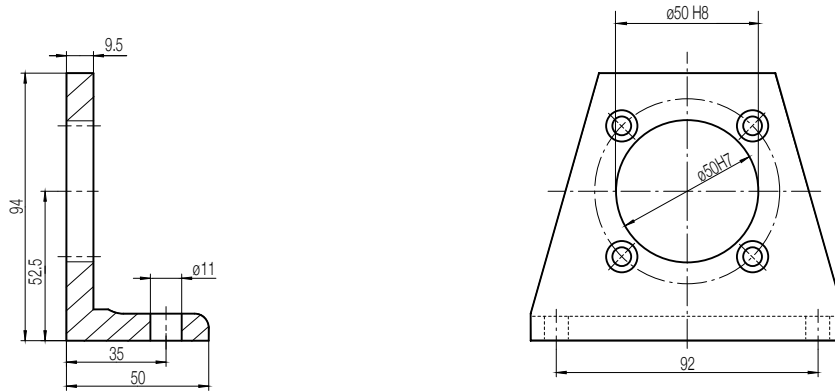

Flanges P1V-MF6, P1V-MF7

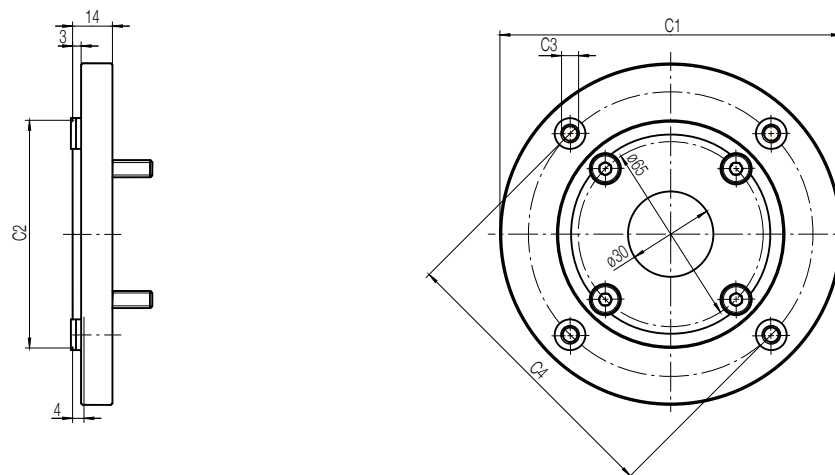

Motor size				Dimensions (mm)	
				A1	A2
1200 watts	P1V-M120C0245	P1V-M120C0156		229	65
	P1V-M120C0058	P1V-M120C0036	P1V-M120C0023	251	65

Motor type	Dimensions (mm)				
	C1	C2	C3	C4	
P1V-M120C	(IEC80 B5) P1V-MF7	200	130f7	11	165
	(IEC80 B14) P1V-MF6	120	80f7	M6	100

Permissible forces air motors with gear boxes

Max. permitted load on output shaft for basic motors (based on 10,000 rpm at input shaft with 90 % probable service life for ball bearings).

a (mm)	Radial force (N)	Axial force (N)
Motors P1V-M020C0230, P1V-M020C0146		
39	240	50
Motors P1V-M020C0054, P1V-M020C0034, P1V-M020C0021		
39	360	70
Motors P1V-M020C0012, P1V-M020C0008, P1V-M020C0003		
39	520	120

Motors P1V-M040C0230, P1V-M040C0146		
39	240	50
Motors P1V-M040C0054, P1V-M040C0034, P1V-M040C0021		
39	360	70
Motors P1V-M040C0012, P1V-M040C0008		
39	520	120

Motors P1V-M060C0230, P1V-M060C0146		
39	240	50
Motors P1V-M060C0054, P1V-M060C0034, P1V-M060C0021		
39	360	70
Motors P1V-M060C0012		
39	520	120

Motors P1V-M090C0245, P1V-M090C0156		
39	400	80
Motors P1V-M090C0058, P1V-M090C0036, P1V-M090C0023		
39	600	120
Motors P1V-M090C0013, P1V-M090C0009, P1V-M090C0004		
39	1000	200

Motors P1V-M120C0245, P1V-M120C0156		
39	400	80
Motors P1V-M120C0058, P1V-M120C0036, P1V-M120C0023		
39	600	120

Permissible forces air motors without gear boxes

	a (mm)	Radial force (N)	Axial force (N)
P1V-M020B	8	145	0
P1V-M040B	8	145	0
P1V-M060B	8	145	0
P1V-M090B	9	145	0
P1V-M120B	9	145	0

Frad = Radial loading (N)

Fax = Axial loading (N)

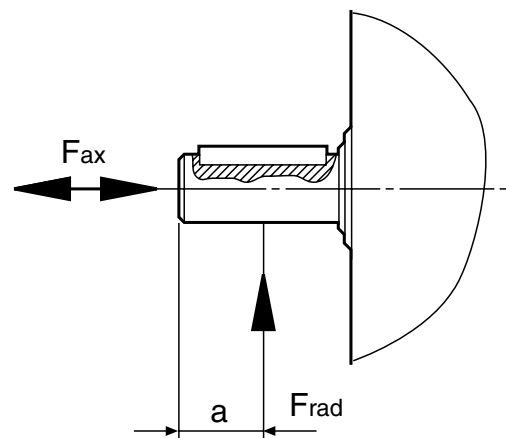

Loads on output shaft for basic motor with shaft with key slot.

Order key

P1V-M

020

B

0

A00

	Motor size
020	200 W
040	400 W
060	600 W
090	900 W
120	1200 W

	Function
B	Basic motor without gearbox, keyed shaft
C	With planetary gear, keyed shaft

	Optional function
0	Standard vanes
Z	Spring loaded vanes

	Air motor range																	
P1V-M	Robust Air Motor																	

Free speed per min	10500	10000	2450	2300	1560	1460	730	580	540	360	340	230	210	134	120	90	80	40	32
	A00	A00	245	230	156	146	073	041	054	036	034	023	021	013	012	009	008	004	003
M020		X		X		X	X		X		X		X		X		X		X
M040		X		X		X	X		X		X		X		X		X		
M060		X		X		X	X		X		X		X		X				
M090	X		X		X			X		X		X		X		X		X	
M120	X		X		X			X		X		X							

Note : This model code can not be used for creating new part numbers. All possible combinations between motor size, function and free speed are in all previous pages except for optional function.



29

Parker Hannifin Corporation
Pneumatic Division - Europe

Service – Easier - Faster - Cheaper

Replacing vanes - step by step.

Step 1.

Remove the rear piece.



Step 2.

Remove the inspection plug.



Step 3.

Use a screwdriver to rotate the motor until you can see a vane in the centre of the inspection hole.



Step 4.

Remove the old vane and replace it with a new one.



Repeat steps 3 and 4 until all the vanes have been replaced.

Step 5.

Replace the inspection plug.



Step 6.

Replace the rear piece.

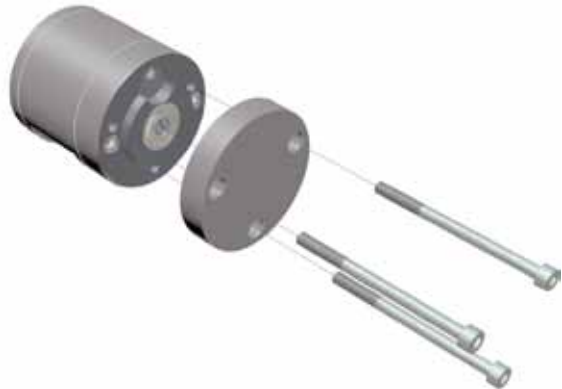

Replacing vanes with motor still fitted to the machine

The P1V-M motor has been developed to allow the vanes to be replaced without the need to remove the motor from the machine. This makes vane replacement easier, quicker and cheaper, while minimising stoppages.

Lubrication and service life

The first service is due after approximately 500 hours of operation. After the first service, the service interval is determined by the degree of vane wear*. The table below shows new dimensions and the minimum dimensions of worn vanes.

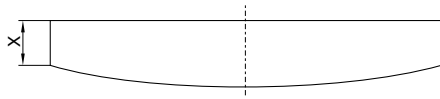

Air motors	Dimensions on new vanes X [mm]	Minimum dimensions on vane X [mm]
P1V-M020	8,5	6,5
P1V-M040	7,0	5,0
P1V-M060	8,0	6,0
P1V-M090	X	X
P1V-M120	X	X

Spare parts

For motor with Z optional option, please consult factory

Motor	Spare parts Order Code	
	Air Motor (1)	Gear Box (2)
P1V-M020C0230	P1V-M/202193A	P1V-M/202202B
P1V-M020C0146	P1V-M/202193A	P1V-M/202202D
P1V-M020C0054	P1V-M/202193A	P1V-M/202202G
P1V-M020C0034	P1V-M/202193B	P1V-M/202202C
P1V-M020C0021	P1V-M/202193B	P1V-M/202202E
P1V-M020C0012	P1V-M/202193B	P1V-M/202202F
P1V-M020C0008	P1V-M/202193B	P1V-M/202202H
P1V-M020C0003	P1V-M/202193B	P1V-M/202202I
Motor	Air Motor (1)	Gear Box (2)
P1V-M040C0230	P1V-M/202194A	P1V-M/202202B
P1V-M040C0146	P1V-M/202194A	P1V-M/202202D
P1V-M040C0054	P1V-M/202194A	P1V-M/202202G
P1V-M040C0034	P1V-M/202194B	P1V-M/202202C
P1V-M040C0021	P1V-M/202194B	P1V-M/202202E
P1V-M040C0012	P1V-M/202194B	P1V-M/202202F
P1V-M040C0008	P1V-M/202194B	P1V-M/202202H
Motor	Air Motor (1)	Gear Box (2)
P1V-M060C0230	P1V-M/202179A	P1V-M/202202B
P1V-M060C0146	P1V-M/202179A	P1V-M/202202D
P1V-M060C0054	P1V-M/202179A	P1V-M/202202G
P1V-M060C0034	P1V-M/202179B	P1V-M/202202C
P1V-M060C0021	P1V-M/202179B	P1V-M/202202E
P1V-M060C0012	P1V-M/202179B	P1V-M/202202F
Motor	Air Motor (1)	Gear Box (2)
P1V-M090C0245	P1V-M/202409A	P1V-M/807015B
P1V-M090C0156	P1V-M/202409B	P1V-M/807015C
P1V-M090C0058	P1V-M/202409A	P1V-M/807015D
P1V-M090C0036	P1V-M/202409B	P1V-M/807015E
P1V-M090C0023	P1V-M/202409B	P1V-M/807015F
P1V-M090C0013	P1V-M/202409A	P1V-M/807015G
P1V-M090C0009	P1V-M/202409B	P1V-M/807015H
P1V-M090C0004	P1V-M/202409B	P1V-M/807015I
Motor	Air Motor (1)	Gear Box (2)
P1V-M120C0245	P1V-M/202457A	P1V-M/807015B
P1V-M120C0156	P1V-M/202457B	P1V-M/807015C
P1V-M120C0058	P1V-M/202457A	P1V-M/807015D
P1V-M120C0036	P1V-M/202457B	P1V-M/807015E
P1V-M120C0023	P1V-M/202457B	P1V-M/807015F

Service kits

The following kits are available for the basic motors, consisting of vanes and (springs).



Service kits, vanes for intermittent lubrication operation, option "0"

For motors	Order code
P1V-M020	P1V-6/831297A
P1V-M040	P1V-6/831298A
P1V-M060	P1V-6/831299A
P1V-M090	P1V-6/831300A
P1V-M120	P1V-6/831301A



Service kits, vanes for intermittent lubrication operation, option "Z"

For motors	Order code
P1V-M020	Consult Factory
P1V-M040	Consult Factory
P1V-M060	Consult Factory
P1V-M090	Consult Factory
P1V-M120	Consult Factory

* The following normal service intervals should be applied in order to guarantee problem-free operation in air motors working at load speeds. The specified hours of operation apply when the motor is running at the speed corresponding to maximum power (load speed). This is approximately half free speed. If the motor operates at higher speeds, the service interval is shorter. If the motor operates at lower speeds, the service interval is longer.



Introduction to the ATEX directive

Explosive atmospheres

Directive 94/9/EC defines an explosive atmosphere as a mixture of:

- a) **flammable substances** – gases, vapours, mists or dusts
 - b) with **air**
 - c) under specific **atmospheric conditions**
 - d) in which, after ignition has occurred, combustion spreads to the entire flammable mixture
- (NB: with regard to dust, it may be that not all dust is combusted after ignition has occurred)

An atmosphere with the potential to become an explosive atmosphere during operating conditions and/or under the influence of the surroundings is defined as a **potentially explosive atmosphere**. Products covered by directive 94/9/EC are defined as intended for use in potentially explosive atmospheres.

Harmonised European ATEX standard

The European Union has adopted two harmonised directives in the field of health and safety. The directives are known as ATEX 100a and ATEX 137.

Directive ATEX 100a (94/9/EC) lays down minimum safety requirements for products intended for use in potentially explosive atmospheres in European Union member states. Directive ATEX 137 (99/92/EC) defines minimum requirements for health and safety at the workplace, for working conditions and for the handling of products and materials in potentially explosive atmospheres. This directive also divides the workplace into **zones** and defines criteria by which products are **categorised** within these zones.

The table below describes the **zones** in an installation where there is a potential for explosive atmospheres. The **owner** of the installation must analyse and assess the area in which the explosive gas/dust mixture may occur, and if necessary must divide it into **zones**. This process of zoning then allows the correct plant and equipment to be selected for use in the area.

The ATEX directive has been in force throughout the European Union

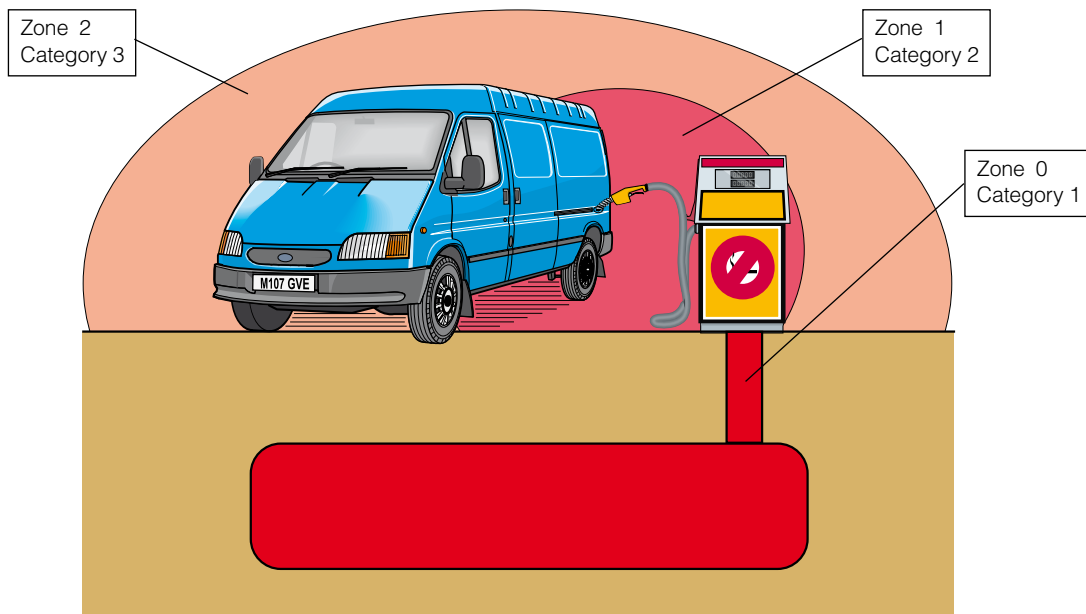

Zones		Presence of potentially explosive atmosphere	Type of risk
Gas G	Dust D		
0	20	Present continuously or for long periods	Permanent
1	21	Likely to occur in normal operation occasionally	Potential
2	22	Not likely to occur in normal operation but, if it does occur, will persist for a short period only	Minimal

since 1 July 2003, replacing the existing divergent national and European legislation relating to explosive atmospheres. Please note that for the first time, the directive covers mechanical, hydraulic and pneumatic equipment and not just electrical equipment as before.

With regard to the **Machinery directive 98/37/EC**, note that a number

of external requirements in 94/9/EC refer to hazards arising from potentially explosive atmospheres, where the Machinery directive only contains general requirements relating to explosion safety (Annex I 1.5.7).

As a result, directive 94/9/EC (ATEX 100a) takes precedence over the Machinery directive with regard to explosion protection in potentially explosive atmospheres. The requirements in the Machinery directive are applicable to all other risks relating to machinery.

P1V-M - Robust Air Motors

Levels of protection for the various equipment categories

The various equipment categories must be capable of operating in accordance with the manufacturer's operating specifications at defined levels of protection.

Level of protection	Category		Type of protection	Operating specifications
	Group I	Group II		
Very high	M1		Two independent means of protection or safety, ensuring that the equipment remains functional even in the event of two faults occurring independently of each other	The equipment remains energised and functional even with an explosive atmosphere present
Very high		1	Two independent means of protection or safety, ensuring that the equipment remains functional even in the event of two faults occurring independently of each other	The equipment remains energised and functional in zones 0, 1, 2 (G) and/or zones 20, 21, 22 (D)
High	M2		Protection suitable for normal operation and severe operating conditions	The equipment is de-energised in the event of an explosive atmosphere
High		2	Protection suitable for normal operation and frequent faults, or equipment in which faults normally have to be taken into account	The equipment remains energised and functional in zones 1, 2 (G) and/or zones 21, 22 (D)
Normal		3	Protection suitable for normal operation	The equipment remains energised and functional in zones 2 (G) and/or zones 22 (D)

Definition of groups (EN 1127-1)

Group I Equipment intended for use in underground parts of mines as well as those parts of surface installations of such mines likely to be endangered by flammable vapours and/or flammable dusts.

Group II Equipment intended for use in other places exposed to explosive atmospheres.

Group	I mines, combustible vapours		II other potentially explosive atmospheres (gases, dust)					
	M1	M2	1		2		3	
Category								
Atmosphere*			G	D	G	D	G	D
Zone			0	20	1	21	2	22

G = gas and D = dust

Temperature classes

Classification of flammable gases and vapours on the basis of ignition temperature

Temperature class	Ignition temperature °C
T1	Over 450
T2	(300) – 450
T3	(200) – 300
T4	(135) – 200
T5	(100) – 135
T6	(85) - 100

Declaration of conformity

The product catalogues contain copies of the declaration of conformity demonstrating that the product meets the requirements of directive 94/9/EC.

The declaration is only valid in conjunction with the instructions contained in the installation manual relating to the safe use of the product throughout its service life.

The instructions relating to the conditions in the surrounding area are particularly important, as the certificate is invalidated if the instructions are found not to have been adhered to during operation of the product. If there is any doubt as to the validity of the certificate of conformity, contact Parker Hannifin customer service.

Operation, installation and maintenance

The installation manual of the product contains instructions relating to the safe storage, handling, operation and servicing of the product.

The manual is available in different languages, and can be downloaded from www.parker.com/euro_pneumatic.

This document must be made accessible in a suitable place near where the product is installed. It is used as a reference for all personnel authorised to work with the product throughout its service life.

We, the manufacturer, reserve the right to modify, extend or improve the installation manual in the interests of the users.

For more information about ATEX see EUs homepage: <http://europa.eu.int/comm/enterprise/ates/>



Additional safety instructions for installation in explosive atmospheres

Serious, even fatal, damage or injury may be caused by the hot moving parts of the air motors in the presence of explosive gas mixtures and concentrations of dust.

All installation, connection, commissioning, servicing and repair work on air motors must be carried out by qualified personnel taking account of the following

- These instructions
- Notices on the motor
- All other planning documents, commissioning instructions and connection diagrams associated with the application.
- Provisions and requirements specific to the application
- Applicable national/international regulations (explosion protection, safety and accident prevention)

Real life applications

Air motors are designed to provide rotary movement in industrial applications, and should only be used in accordance with the instructions in the technical specifications in the catalogue, and within the operating range indicated on the motor housing. The motors meet the applicable standards and requirements of the Machinery Directive 94/9/EC (ATEX)

The motors must not be used as brakes in explosive atmospheres.

Braking involves driving the motor against the direction of rotation for which the motor is supplied with compressed air. The motor is then operating as a compressor, and there is a corresponding increase in temperature.

The motors must **not** be used underground in mines susceptible to firedamp and/or combustible dust. The motors are intended for use in areas in which explosive atmospheres caused by gases, vapours or mists of combustible liquids, or air/dust mixtures may be expected to occur during normal use (infrequently)

Checklist

Before using the motors in a potentially explosive atmosphere, you should check the following:

Do the motor specifications match the classification of the area of use in accordance with Directive 94/9/EG (previously ATEX 100a)

- Equipment group
 - Equipment category
 - Zone
 - Temperature class
 - Max. surface temperature
1. When installing the motor, is it certain that there is no potentially explosive atmosphere, oil, acids, gases, vapours or radiation?
 2. Is the ambient temperature as specified in the technical data in the catalogue at all times?
 3. Is it certain that the air motor is adequately ventilated and that no additional heat is added (for example in the shaft connection)?
 4. Are all the driven mechanical components ATEX certified?

Installation requirements in potentially explosive atmospheres

- The temperature of the supply air must not exceed the ambient temperature.
- The air motor may be installed in any position.
- An air treatment unit must be attached to the inlet of the air motor.
- In a potentially explosive atmosphere, none of the motor ports may be blocked because this may cause an increase in temperature. The air from the port must be taken to the silencer or, preferably, outside the potentially explosive area.
- The air motor must be connected to ground at all times, through its support, a metallic tube or separate conductor.
- The outlet of the air motor must not open within a potentially explosive area, but must be passed to the silencer or, preferably, removed and released outside the potentially explosive area.
- The air motor may only drive units that are ATEX certified.
- Ensure that the motor is not exposed to forces greater than those permitted in accordance with the catalogue.

Measuring the temperature on the outside of the air motor (only when used in potentially explosive areas)

During the commissioning process, it is essential to measure temperature increases at the indicated positions on the outside of the air motor.

These measurements can be taken using standard thermometers.

Checking the motor during operation

The motor must be kept clean on the outside, and a layer of dirt thicker than 5 mm must never be allowed to form.

Strong solvents should not be used for cleaning, because they can cause the seal (material NBR/FPM) around the drive shaft to swell, potentially increasing the temperature.

P1V-M Declaration of Conformity

According to ATEX 94/9/EC

P1V-M Declaration of Incorporation

According to EC Machinery Directive 2006/42/EC



We Parker Hannifin Manufacturing
Germany GmbH & Co. KG
Pneumatic Division Europe
Industriestrasse 8
70794 Filderstadt Germany

Declare that the following Pneumatic Air Motors have been assessed in accordance with ATEX 94/9/EC (Products for use in potentially explosive atmospheres). Air Motors here below from the **P1V-M series** are compatible for the use in explosive atmosphere **Ex II 2 GD c IIC T4 (130°C) X**.

P/Ns are without gear boxes : P1V-M020B*xxx, P1V-M040B*xxx, P1V-M060B*xxx, P1V-M090B*xxx, P1V-M120B*xxx
And P/Ns with gear boxes are : P1V-M020C*xxx, P1V-M040C*xxx, P1V-M060C*xxx, P1V-M090C*xxx, P1V-M120C*xxx; * for internal vanes option 0 or Z, xxx for speed range
With *: for internal vanes option 0 or Z, xxx: for speed range

P1V-M is designed for utilization in applications falling under the scope of the ATEX 94/9/EC. These products are designed and manufactured in compliance with following elements:

- **EN 1127-1:2007** Explosive atmospheres – Explosion prevention and protection – Part 1: Basic concepts and methodology
- **EN 13463-1:2009** Non electrical equipment for use in potentially explosive atmospheres – Part 1: Basic method and requirements
- **EN 13463-5** Non-electrical equipment intended for use in potentially explosive atmospheres – Part 5: Protection by constructional safety ‘c’
- **EN 983+A1:2008** Safety of machinery – Safety requirements for fluid power systems and their components - Pneumatics

As manufacturer of the partly completed machinery we declare that:

- The specified Air motors correspond to the listed essential requirements of the **EC Machinery Directive 2006/42/EC**
- The relevant technical documentation is compiled in accordance with **part B of Annex VII**
- The relevant technical documentation in accordance with part B of Annex VII will be transmitted in response to a reasonable request by the national authorities

Product: Pneumatic Air Motors P1V-M series

Directives	Date	Applied and fulfilled essential requirements
2006/42/EC	2006-06	1.1.2, 1.1.5, 1.3.4, 1.5.3, 1.7.3, 1.7.4
Standards	Date	Remark
DIN EN ISO 12100	2011-03	Partly fulfilled

This partly completed machinery must not be put into service until the final machinery into which it is to be incorporated has been declared in conformity with the provisions of the Directive 2006/42/EG, were appropriated.

Sticker	<p>Additional Information This coverage could only be referred to as long as operations needed for final assembling and starting up of these products comply with standards relating to the above mentioned directive. Each time this will be required for compliance purpose, the user will have to apply for a complete coverage of the final assembled system according to the above mentioned directive and relating standards</p>
---------	---

Filderstadt, Germany June 2014

Ing. Franck Roussillon
European Product Manager
Actuators Business Unit, Pneumatic Division Europe

Parker Worldwide

Europe, Middle East, Africa

AE – United Arab Emirates,
Dubai

Tel: +971 4 8127100
parker.me@parker.com

AT – Austria, Wiener Neustadt

Tel: +43 (0)2622 23501-0
parker.austria@parker.com

AT – Eastern Europe, Wiener
Neustadt

Tel: +43 (0)2622 23501 900
parker.easteurope@parker.com

AZ – Azerbaijan, Baku

Tel: +994 50 2233 458
parker.azerbaijan@parker.com

BE/LU – Belgium, Nivelles

Tel: +32 (0)67 280 900
parker.belgium@parker.com

BY – Belarus, Minsk

Tel: +375 17 209 9399
parker.belarus@parker.com

CH – Switzerland, Etoy

Tel: +41 (0)21 821 87 00
parker.switzerland@parker.com

CZ – Czech Republic, Klecany

Tel: +420 284 083 111
parker.czechrepublic@parker.com

DE – Germany, Kaarst

Tel: +49 (0)2131 4016 0
parker.germany@parker.com

DK – Denmark, Ballerup

Tel: +45 43 56 04 00
parker.denmark@parker.com

ES – Spain, Madrid

Tel: +34 902 330 001
parker.spain@parker.com

FI – Finland, Vantaa

Tel: +358 (0)20 753 2500
parker.finland@parker.com

FR – France, Contamine s/Arve

Tel: +33 (0)4 50 25 80 25
parker.france@parker.com

GR – Greece, Athens

Tel: +30 210 933 6450
parker.greece@parker.com

HU – Hungary, Budapest

Tel: +36 23 885 475
parker.hungary@parker.com

IE – Ireland, Dublin

Tel: +353 (0)1 466 6370
parker.ireland@parker.com

IT – Italy, Corsico (MI)

Tel: +39 02 45 19 21
parker.italy@parker.com

KZ – Kazakhstan, Almaty

Tel: +7 7272 505 800
parker.easteurope@parker.com

NL – The Netherlands, Oldenzaal

Tel: +31 (0)541 585 000
parker.nl@parker.com

NO – Norway, Asker

Tel: +47 66 75 34 00
parker.norway@parker.com

PL – Poland, Warsaw

Tel: +48 (0)22 573 24 00
parker.poland@parker.com

PT – Portugal, Leca da Palmeira

Tel: +351 22 999 7360
parker.portugal@parker.com

RO – Romania, Bucharest

Tel: +40 21 252 1382
parker.romania@parker.com

RU – Russia, Moscow

Tel: +7 495 645-2156
parker.russia@parker.com

SE – Sweden, Spånga

Tel: +46 (0)8 59 79 50 00
parker.sweden@parker.com

SK – Slovakia, Banská Bystrica

Tel: +421 484 162 252
parker.slovakia@parker.com

SL – Slovenia, Novo Mesto

Tel: +386 7 337 6650
parker.slovenia@parker.com

TR – Turkey, Istanbul

Tel: +90 216 4997081
parker.turkey@parker.com

UA – Ukraine, Kiev

Tel +380 44 494 2731
parker.ukraine@parker.com

UK – United Kingdom, Warwick

Tel: +44 (0)1926 317 878
parker.uk@parker.com

ZA – South Africa, Kempton Park

Tel: +27 (0)11 961 0700
parker.southafrica@parker.com

North America

CA – Canada, Milton, Ontario

Tel: +1 905 693 3000

US – USA, Cleveland

Tel: +1 216 896 3000

Asia Pacific

AU – Australia, Castle Hill

Tel: +61 (0)2-9634 7777

CN – China, Shanghai

Tel: +86 21 2899 5000

HK – Hong Kong

Tel: +852 2428 8008

IN – India, Mumbai

Tel: +91 22 6513 7081-85

JP – Japan, Tokyo

Tel: +81 (0)3 6408 3901

KR – South Korea, Seoul

Tel: +82 2 559 0400

MY – Malaysia, Shah Alam

Tel: +60 3 7849 0800

NZ – New Zealand, Mt Wellington

Tel: +64 9 574 1744

SG – Singapore

Tel: +65 6887 6300

TH – Thailand, Bangkok

Tel: +662 186 7000-99

TW – Taiwan, Taipei

Tel: +886 2 2298 8987

South America

AR – Argentina, Buenos Aires

Tel: +54 3327 44 4129

BR – Brazil, Sao Jose dos Campos

Tel: +55 800 727 5374

CL – Chile, Santiago

Tel: +56 2 623 1216

MX – Mexico, Apodaca

Tel: +52 81 8156 6000

European Product Information Centre

Free phone: 00 800 27 27 5374

(from AT, BE, CH, CZ, DE, DK, EE, ES, FI,
FR, IE, IL, IS, IT, LU, MT, NL, NO, PL, PT, RU,
SE, SK, UK, ZA)

Parker Hannifin Ltd.

Tachbrook Park Drive
Tachbrook Park,
Warwick, CV34 6TU
United Kingdom
Tel.: +44 (0) 1926 317 878
Fax: +44 (0) 1926 317 855
parker.uk@parker.com
www.parker.com

